

1

2

3

4

A

A

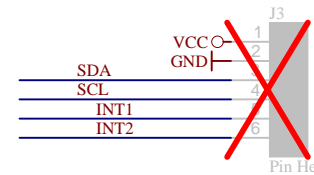
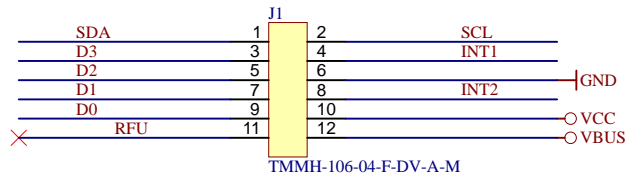
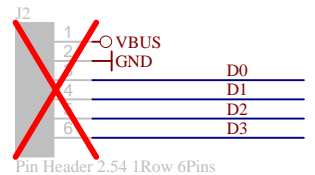
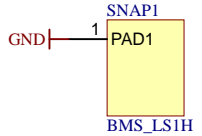
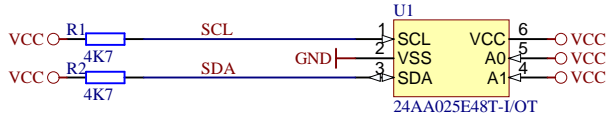

B

B

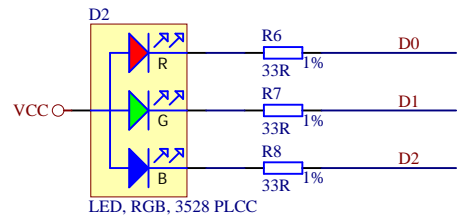
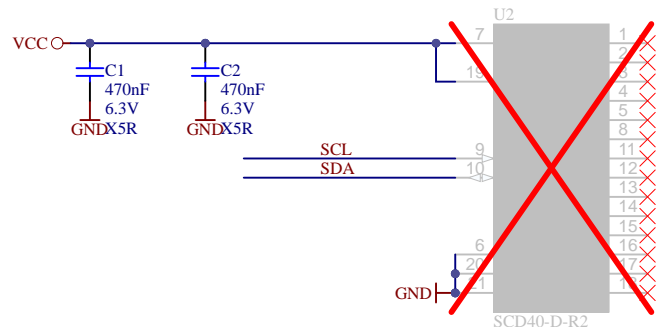

C

C

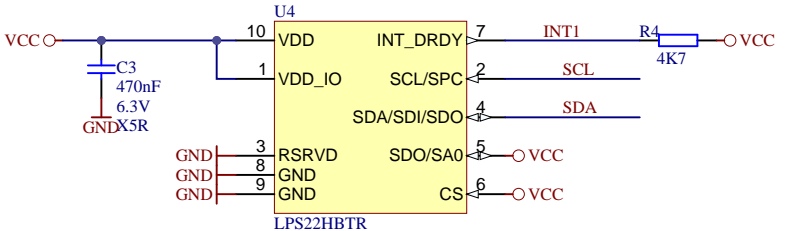
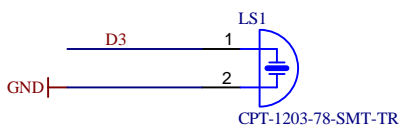
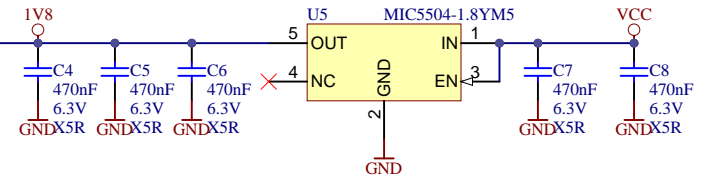
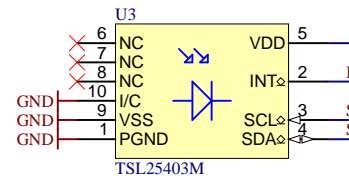
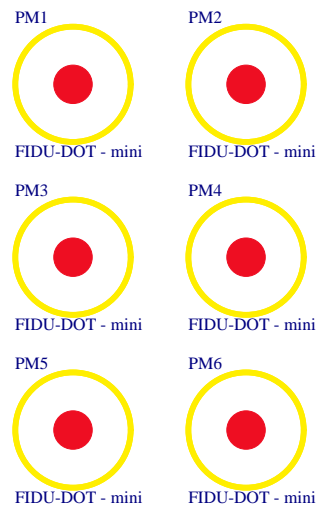

Assembly variant	0
Created by	VT
Modified by	VT
Modified at	2021-03-22
SVN Revision	897 [Locally Modified]

Serial
 Serialnumber 6,3 x 6,3mm



Title: Design licensed from MicroFPGA UG(h)		
A4	Number: 0	Rev. 01
Date: 2021-03-23	Copyright: Trenz Electronic GmbH	Page 1 of 1
Filename: CR00040.SchDoc		

1

2

3

4

D

D