

1

2

3

4

A

A

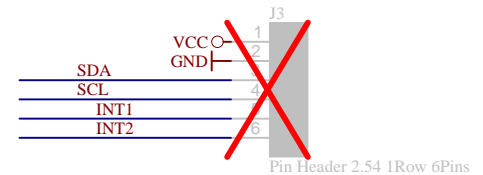
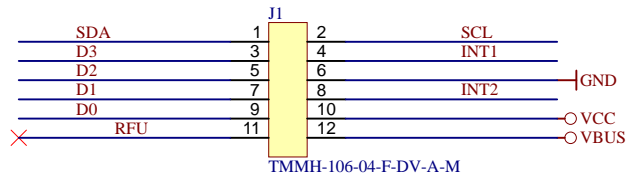
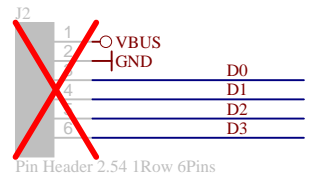
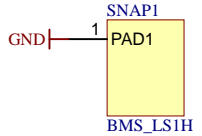
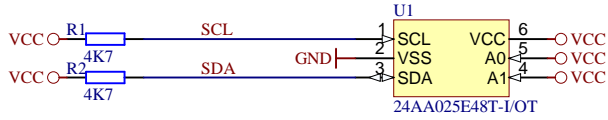

B

B

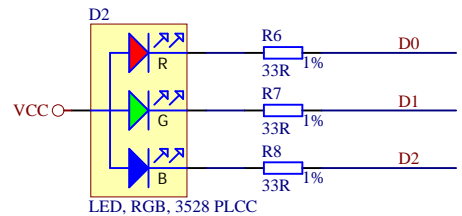
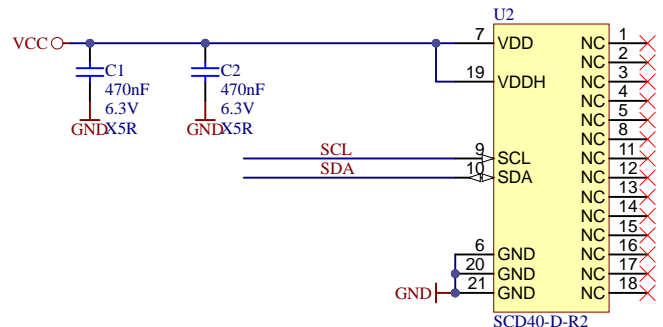

C

C

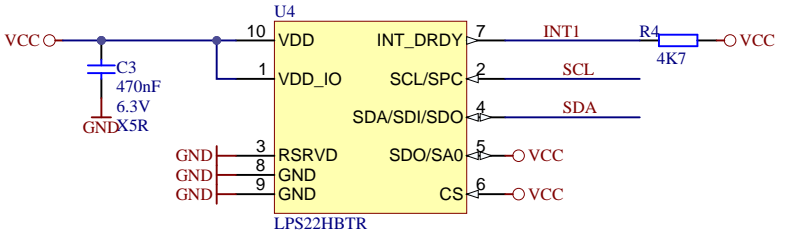
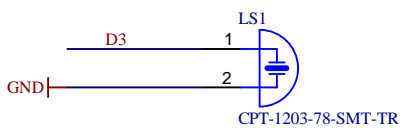
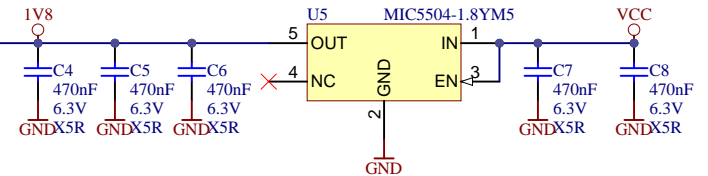
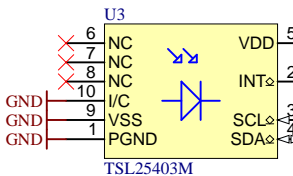
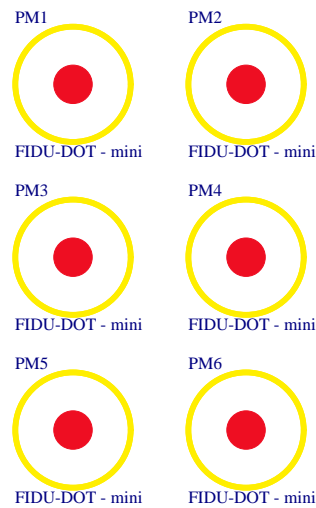

Assembly variant	default
Created by	
Modified by	
Modified at	
SVN Revision	897

D

D

Serial  
 Serialnumber 6,3 x 6,3mm



Title: Design licensed from MicroFPGA UG(h)		
A4	Number: default	Rev. 00
Date: 15.02.2021	Copyright: Trenz Electronic GmbH	Page 0 of 0
Filename: CR00040.SchDoc		

1

2

3

4