

1

2

3

4

A

A

B

B

C

C

D

D

Regarding the usage of our schematics and alike documentation for Trenz module CR00045.

Project is protected under copyright and we strongly and strictly prohibit the reverse engineering or recreation, even if the design is just adapted or modified. CR00045 is protected under such right and in case of plagiarism we will have to do anything necessary in order to protect our assets.

Schematics and other handouts serve for informational purposes only!

		Title: CR00045 – Legal Notices Modules		
		A4	Number: Legal Notices Modules 0	Rev. 01
		Date: 31.10.2024	Copyright: Trenz Electronic GmbH	Page 1 of 4
Filename: Legal Notices Modules.SchDoc				

1

2

3

4

CRUVI
CRUVI.SchDoc

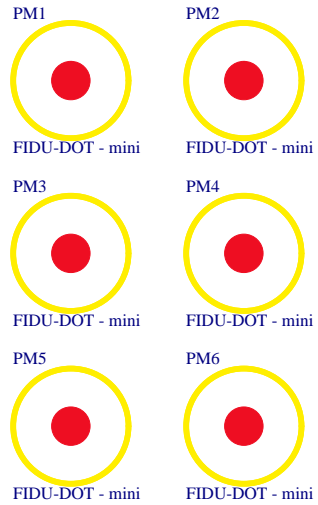
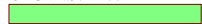

Serial1
Serial
Serialnumber 6,3 x 6.3mm

Assembly variant 0
Created by MR
Modified by MR
Modified at 2019-10-29

	Title: CR00045		
	A4	Number: CR00045 0	Rev. 01
	Date: 31.10.2024	Copyright: Trenz Electronic GmbH	Page 2 of 4
	Filename: CR00045.SchDoc		

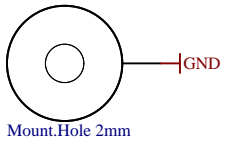

SNAPI
SNAP CRUVI 3x

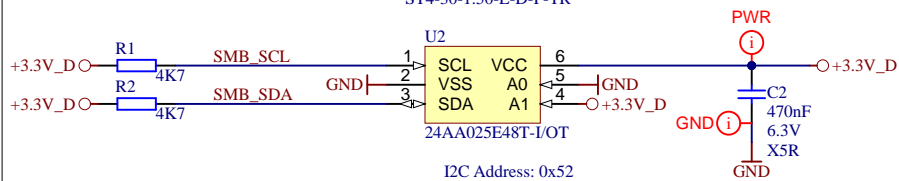
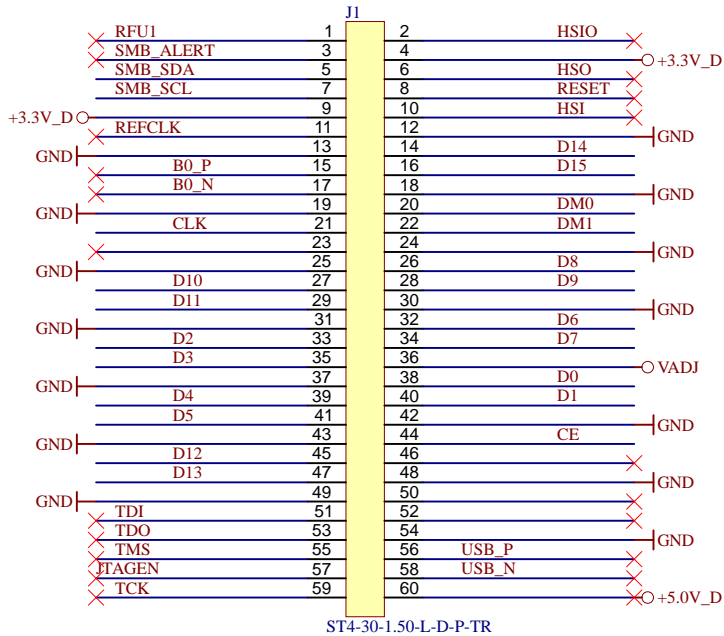
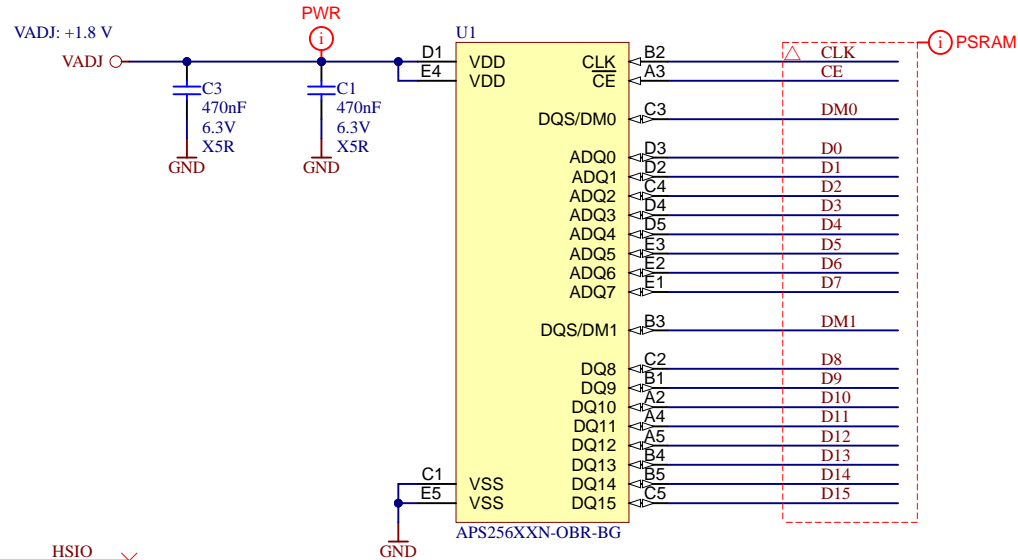

Title: CR00045 – CRUVI		
A4	Number: CR00045 0	Rev. 01
Date: 31.10.2024	Copyright: Trenz Electronic GmbH	Page 3 of 4
Filename: CRUVI.SchDoc		

1

2

3

4

Initial Revision

A

A

B

B

C

C

D

D

	Title: CR00045 – Revision_Changes		
	A4	Number: Revision_Changes 0	Rev. 01
	Date: 21.05.2021	Copyright: Trenz Electronic GmbH	Page 4 of 4
	Filename: Revision_Changes.SchDoc		

1

2

3

4