

A

B

C

D

A

B

C

D

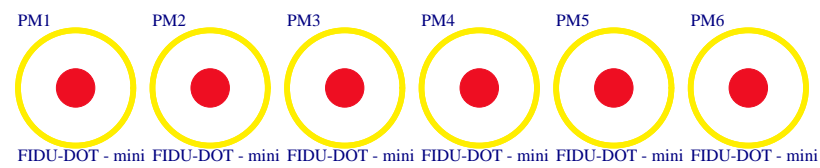
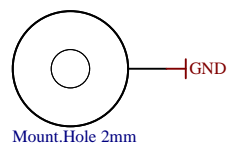
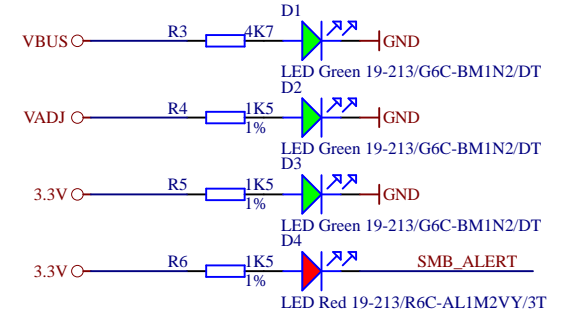
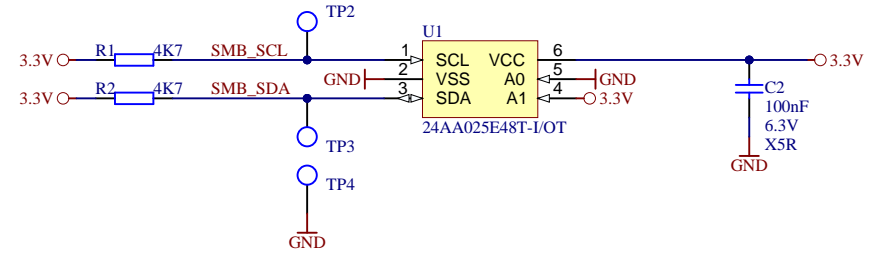
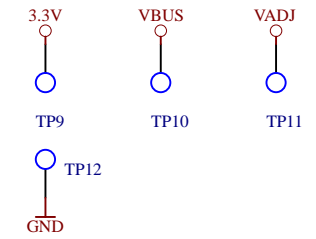
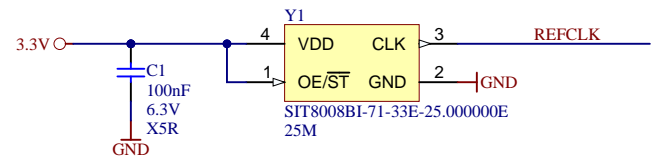
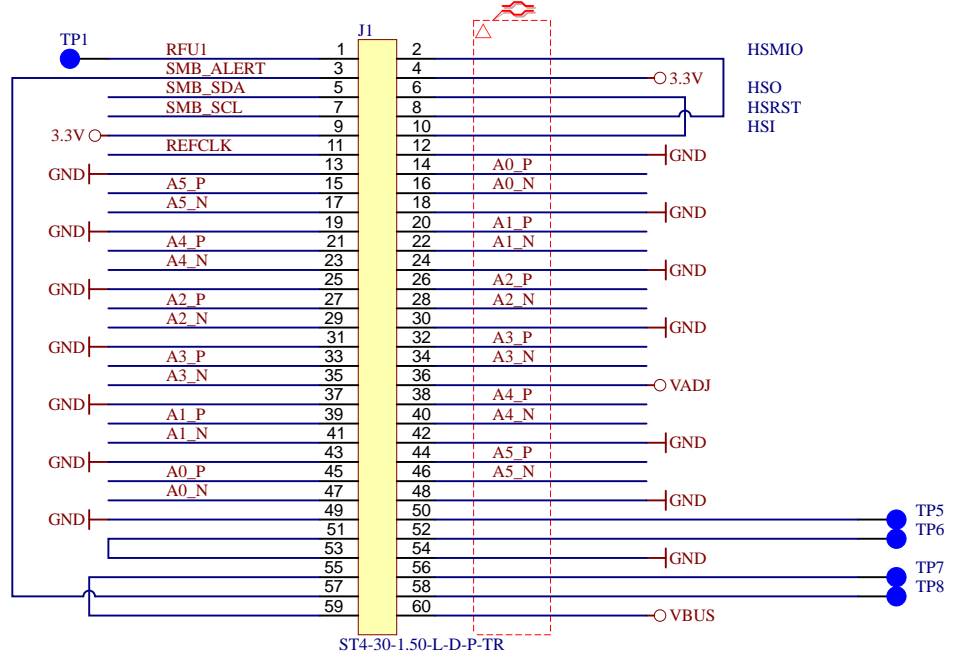

Title: CR00091 Design licensed from MicroFPGA UG(h)		
A4	Number: CR00091 Default	Rev. 01
Date: 25.01.2022	Copyright: Trenz Electronic GmbH	Page 1 of 2
Filename: CR00091.SchDoc		

1

2

3

4

REV	DATE	Description	
-01		Initial revision	AL

A

A

B

B

C

C

D

D

	Title: <b>Revision Changes</b>		
	A4	Number: <b>CR00091</b> <b>Default</b>	Rev. <b>01</b>
	Date: <b>26.01.2022</b>	Copyright: <b>Trenz Electronic GmbH</b>	Page <b>2</b> of <b>2</b>
	Filename: <b>Revision_Changes.SchDoc</b>		

1

2

3

4