

U\_B2B\_Connectors  
B2B\_Connectors.SchDoc

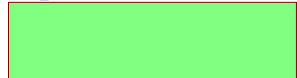

U\_xmod  
xmod.SchDoc

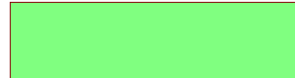

U\_SFP  
SFP.SchDoc



Mount.Hole 3.2mm

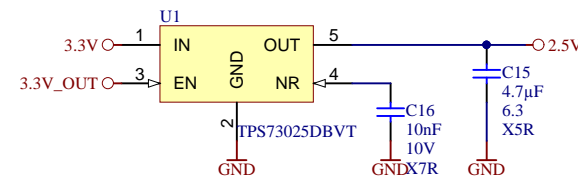
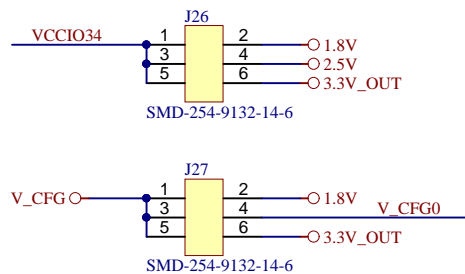
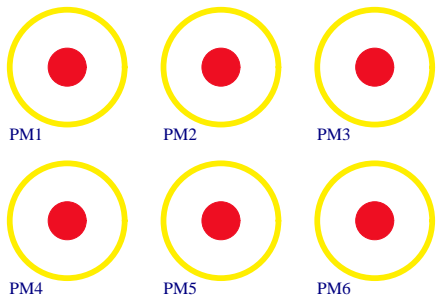
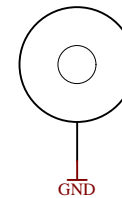

Mount.Hole 3.2mm Mount.Hole 3.2mm

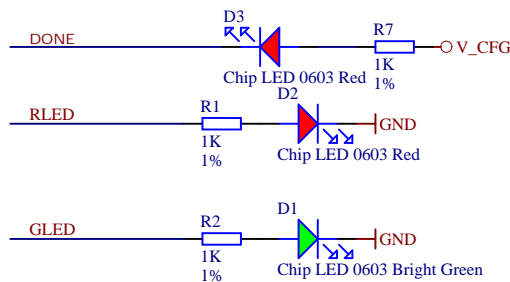
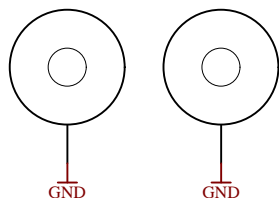

SNAP for TE0714 (40x30 mm)

LOGO1  
TE Logo PRINT Layer  
LOGO PRINT

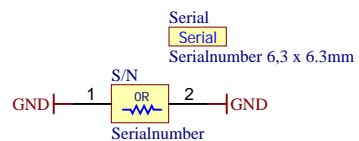

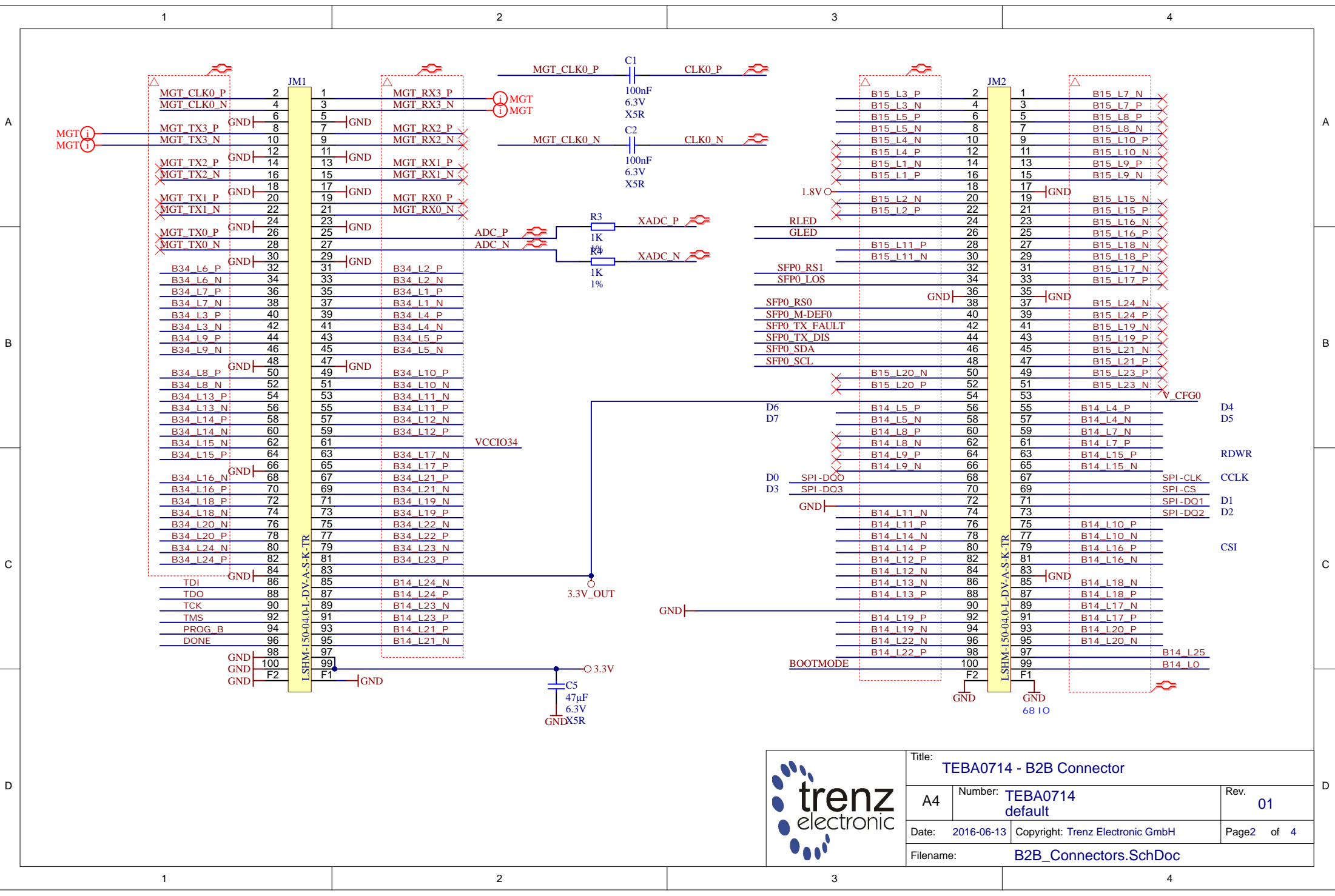

		Title: <b>TEBA0714</b>	
		A4	Number: <b>TEBA0714 default</b>
Date: 2016-06-13		Copyright: Trenz Electronic GmbH	
Page 1		of 4	
Filename: <b>TEBA0714.SchDoc</b>			

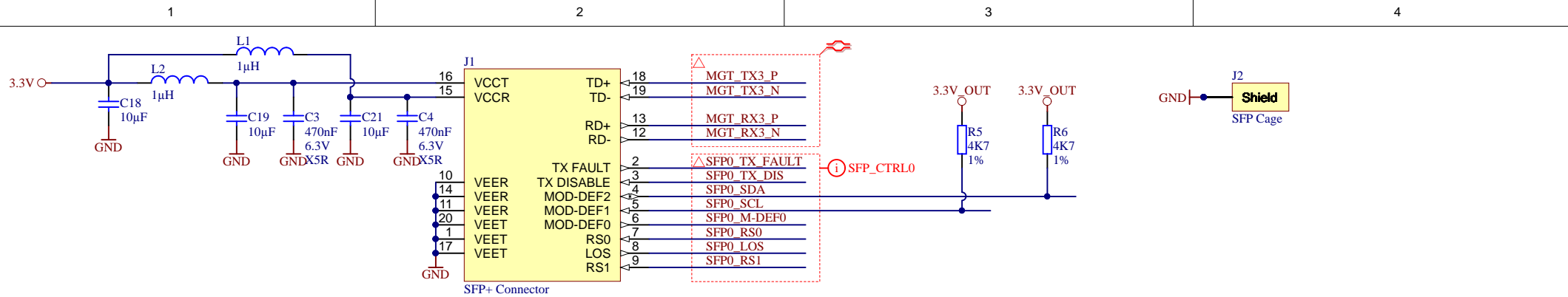

**trenz electronic**

Title: <b>TEBA0714 - B2B Connector</b>		
A4	Number: <b>TEBA0714 default</b>	Rev. <b>01</b>
Date: <b>2016-06-13</b>	Copyright: <b>Trenz Electronic GmbH</b>	Page <b>2</b> of <b>4</b>
Filename: <b>B2B_Connectors.SchDoc</b>		



	Title: <b>TEBA0714 - SFP</b>		
	A4	Number: <b>TEBA0714 default</b>	Rev. <b>01</b>
	Date: <b>2016-06-13</b>	Copyright: <b>Trenz Electronic GmbH / TT</b>	Page <b>3</b> of <b>4</b>
	Filename: <b>SFP.SchDoc</b>		

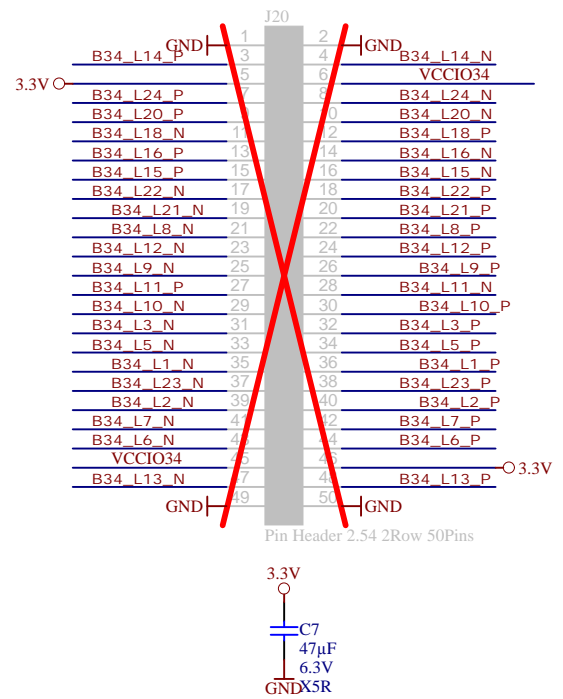
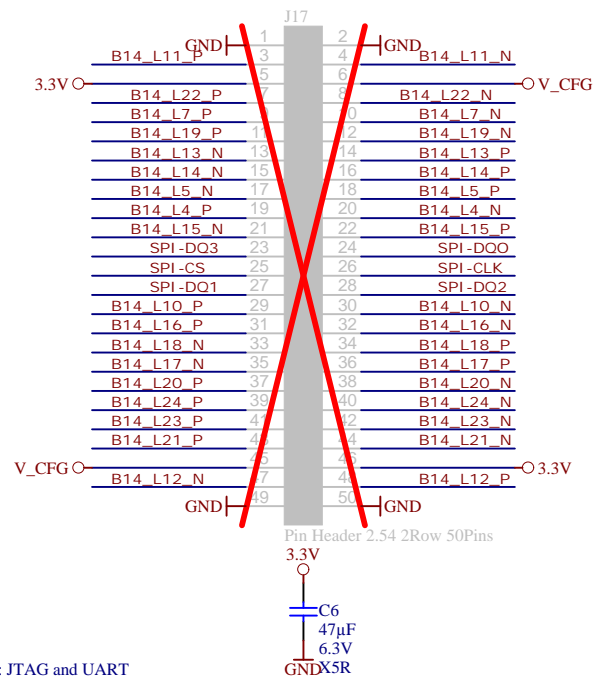

- CCLK
- D0
- D2
- D4
- D6
- RDWR
- CSI
- D1
- D3
- D5
- D7

XMOD-FT2232H header: JTAG and UART

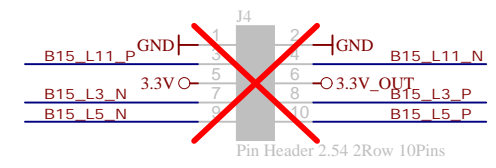
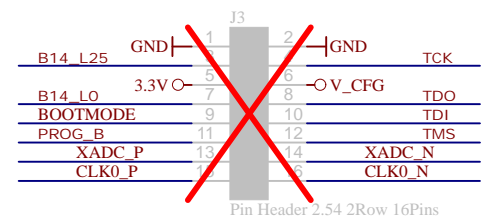
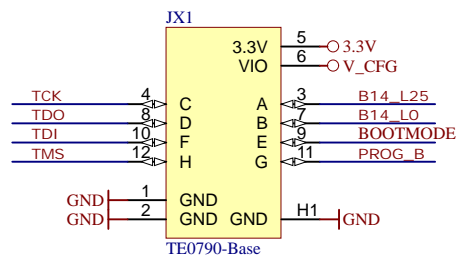

Title: TEBA0714 - xmod		
A4	Number: TEBA0714 default	Rev. 01
Date: 2016-06-13	Copyright: Trenz Electronic GmbH / TT	Page 4 of 4
Filename: xmod.SchDoc		