

U_FPGA_IO
FPGA_IO.SchDoc



U_FPGA_MGT
FPGA_MGT.SchDoc



U_FPGA_MISC
FPGA_MISC.SchDoc



U_B2B_Connector
B2B_Connector.SchDoc



U_POWER
POWER.SchDoc



U_Revision
Revision Changes.SchDoc

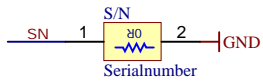

LOGO1



LOGO PRINT

FIDU-DOT - small FIDU-DOT - small

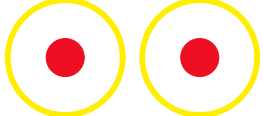

PM1 PM2
FIDU-DOT - small FIDU-DOT - small

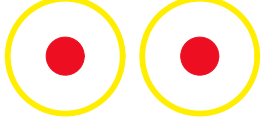

PM4 PM5
FIDU-DOT - small FIDU-DOT - small

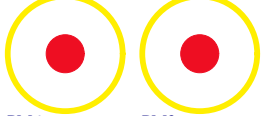

PM6 PM3

Top of Board



Screw M3x4

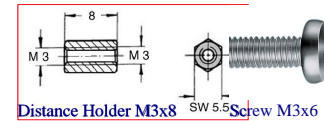

Distance Holder M3x8

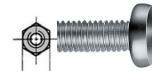

Screw M3x6

Mount.Hole 3.2mm

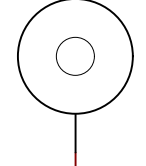

GND

Mount.Hole 3.2mm

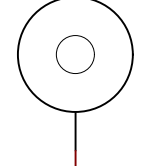

GND

Mount.Hole 3.2mm

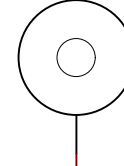

GND

Mount.Hole 3.2mm

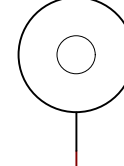

GND



Screw M3x4

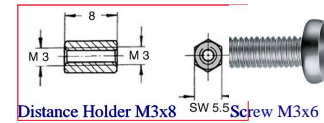

Distance Holder M3x8

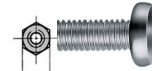

Screw M3x6



Title: TE0714		
A4	Number: 1 50-2IC6	Rev. 02
Date: 2016-08-04	Copyright: Trenz Electronic GmbH / TT	Page 1 of 7
Filename: TE0714.SchDoc		

A

B

C

D

A

B

C

D

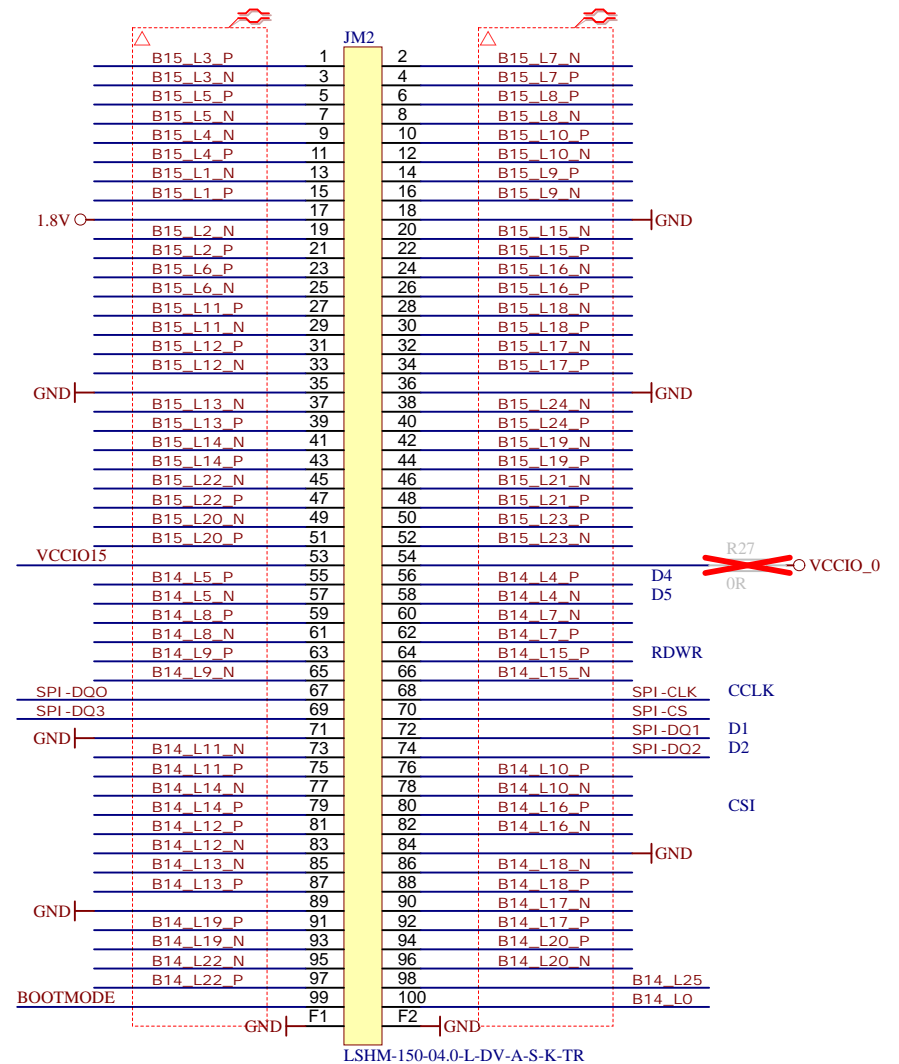
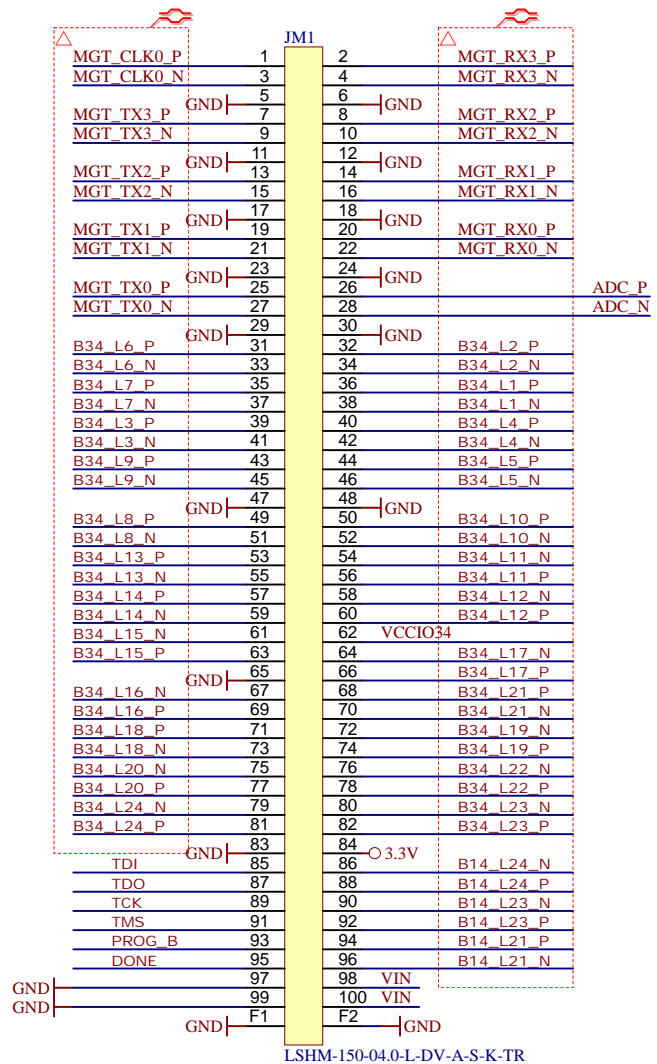

Title: TE0714		
A4	Number: 2 50-2IC6	Rev. 02
Date: 2016-08-04	Copyright: Trenz Electronic GmbH / TT	Page2 of 7
Filename: B2B_Connector.SchDoc		

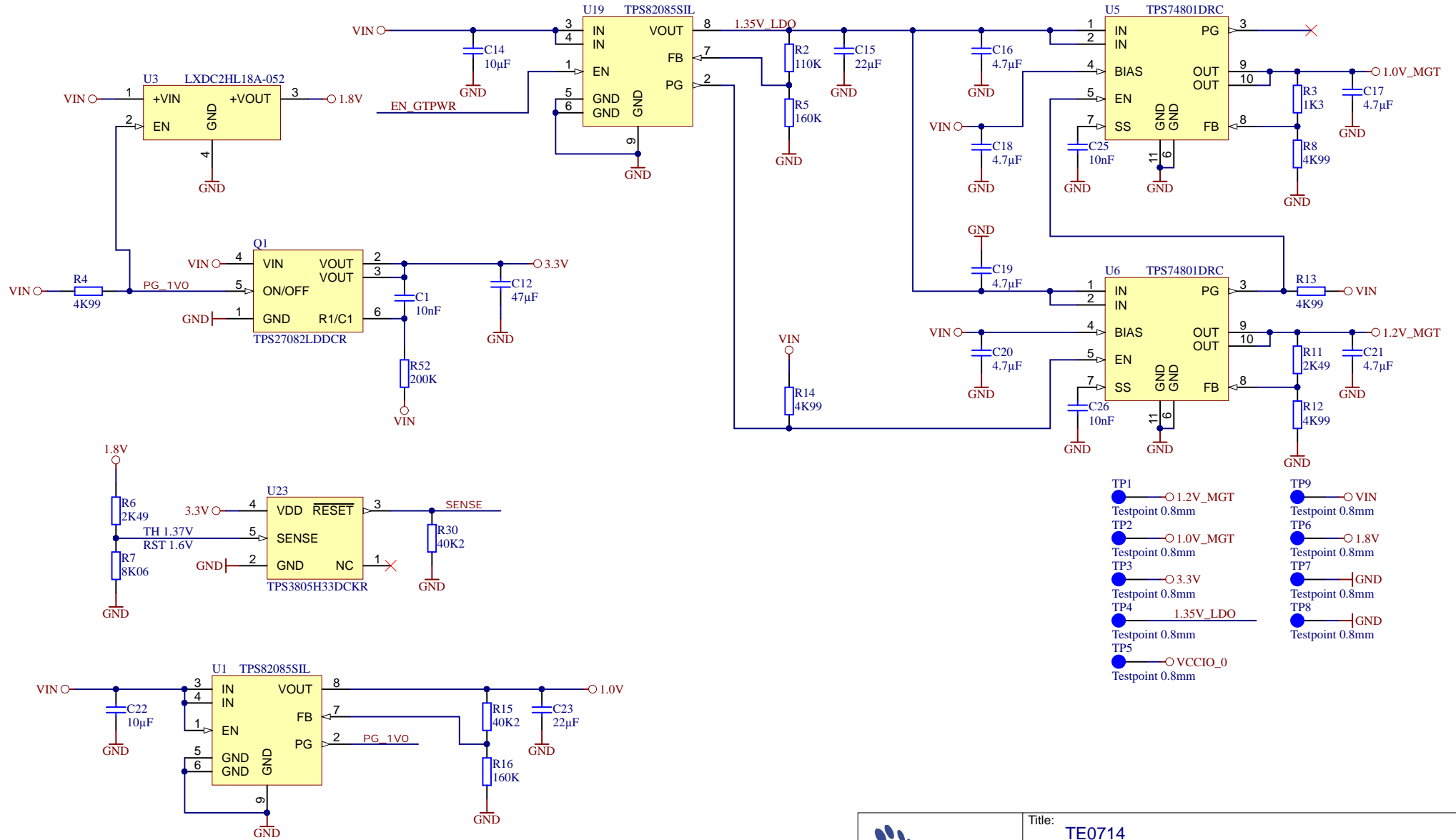

- TP1 — 1.2V_MGT Testpoint 0.8mm
- TP2 — 1.0V_MGT Testpoint 0.8mm
- TP3 — 3.3V Testpoint 0.8mm
- TP4 — 1.35V_LDO Testpoint 0.8mm
- TP5 — VCCIO_0 Testpoint 0.8mm
- TP6 — 1.8V Testpoint 0.8mm
- TP7 — GND Testpoint 0.8mm
- TP8 — GND Testpoint 0.8mm
- TP9 — VIN Testpoint 0.8mm

		Title: TE0714	
		A4	Number: 3 50-2IC6
Date: 2016-08-04		Copyright: Trenz Electronic GmbH	
Page 3		of 7	
Filename: POWER.SchDoc			

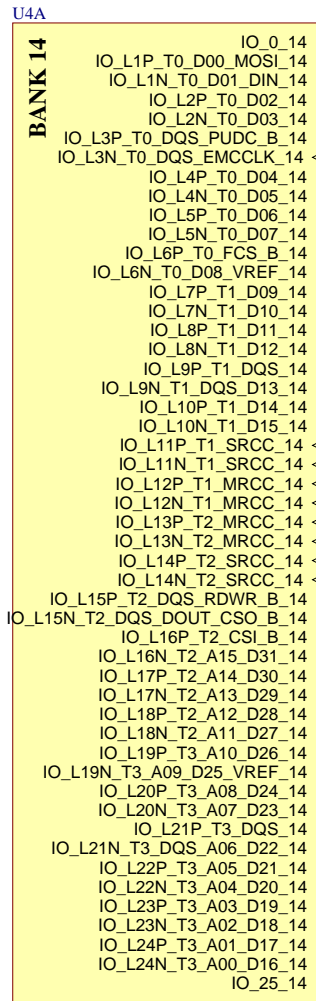

XC7A50T-2CSG3251

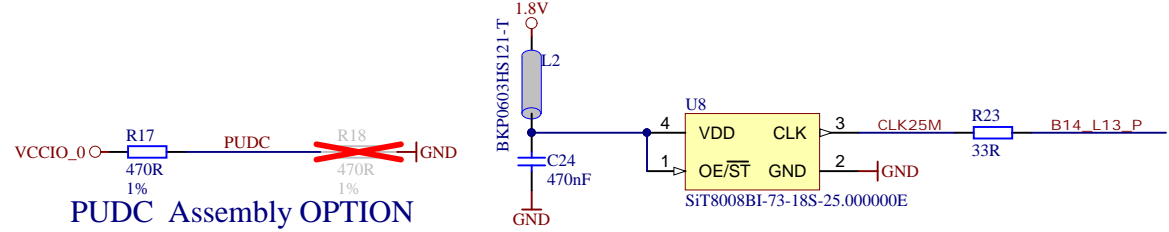

1

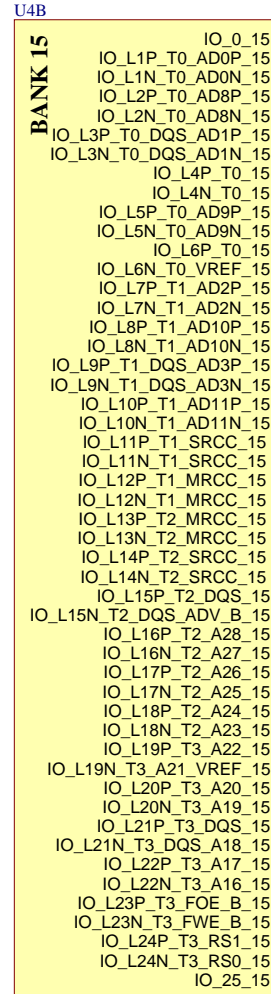

XC7A50T-2CSG3251



Title: TE0714	
A4	Number: 4
50-2IC6	
Date: 2016-08-04	Copyright: Trenz Electronic GmbH / TT
Page 4	of 7
Filename: FPGA_IO.SchDoc	

3

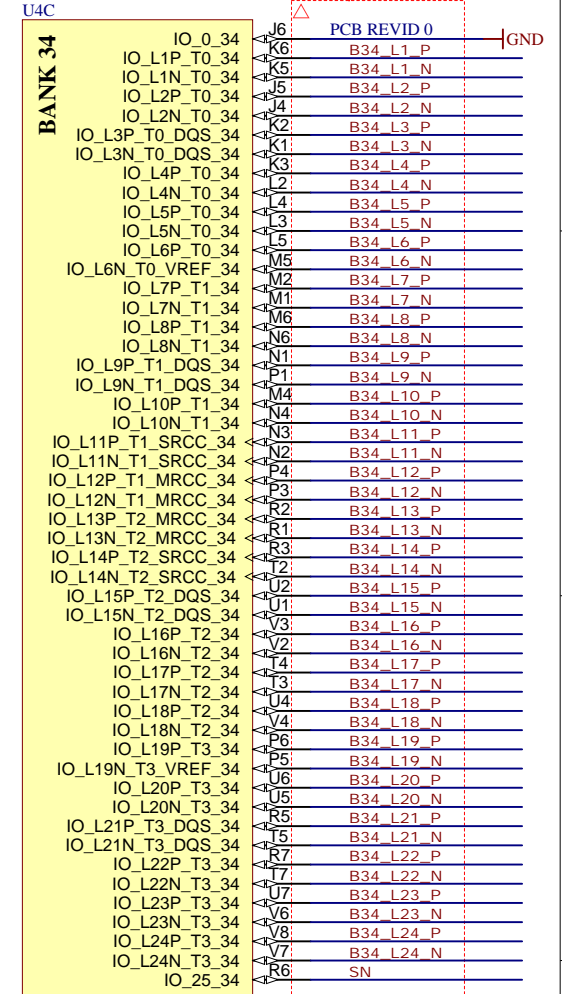

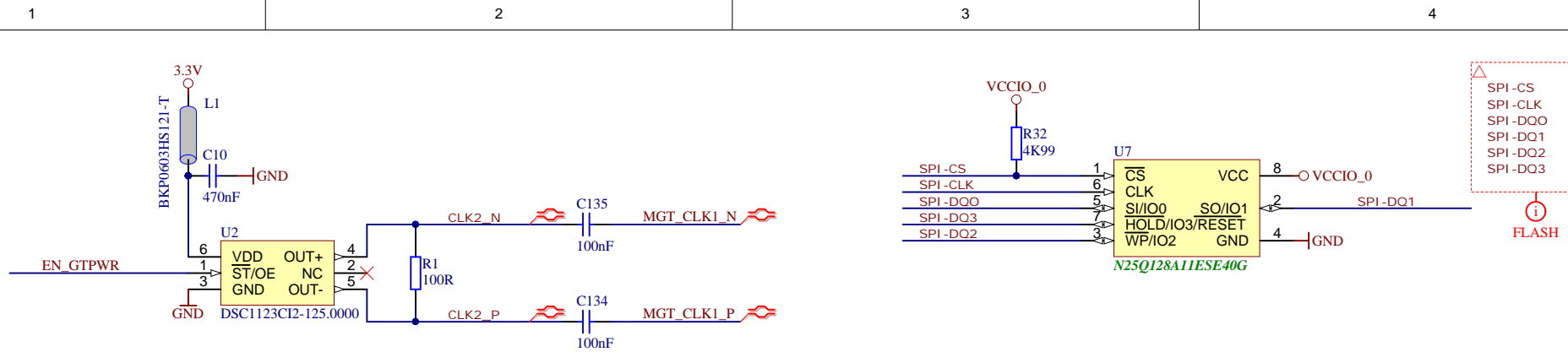

XC7A50T-2CSG3251

4

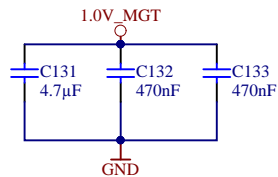
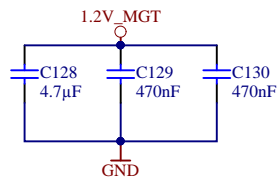
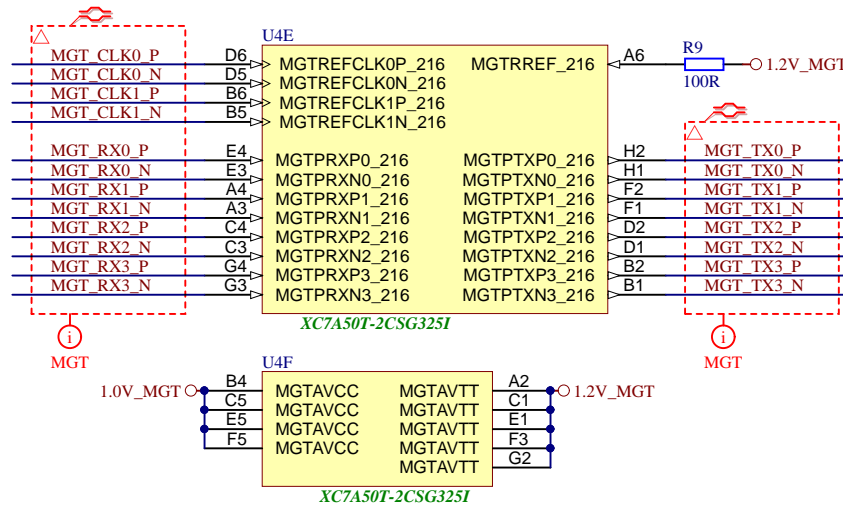

OSC FREQ is Assembly OPTION = 125MHZ



			Title: TE0714	
			A4	Number: 5 50-2IC6
Date: 2016-08-04		Copyright: Trenz Electronic GmbH / TT		Page5 of 7
Filename: FPGA_MGT.SchDoc				

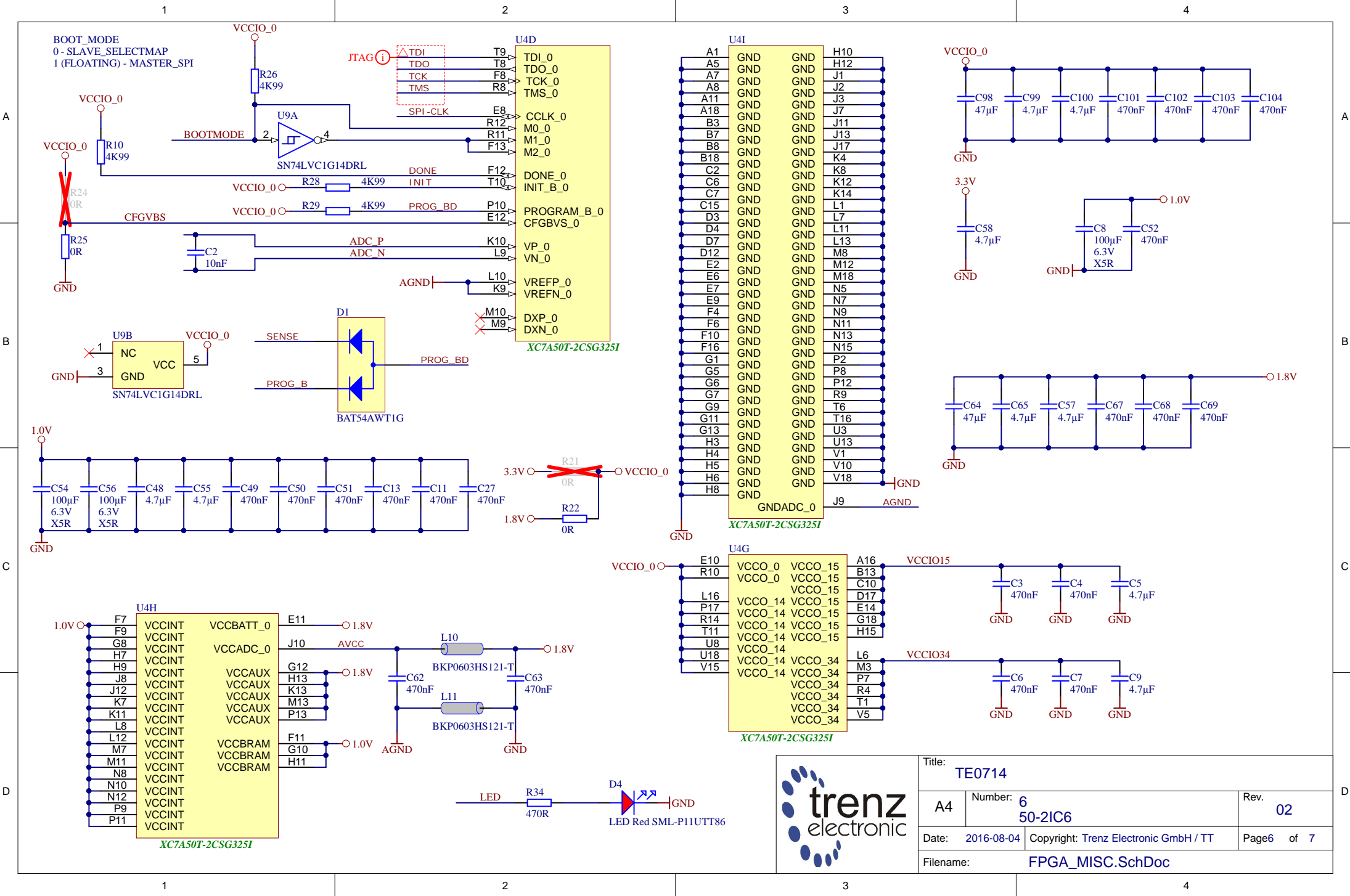

Title: TE0714		
A4	Number: 6 50-2IC6	Rev. 02
Date: 2016-08-04	Copyright: Trenz Electronic GmbH / TT	Page6 of 7
Filename: FPGA_MISC.SchDoc		

1

2

3

4

Changes REV 02:

- 1. Added 0 ohm strap option to supply VCCIO0 on B2B connector
- 2. Added PCB Revision sense support. PCB Revision readout possible from HDL Design
- 3. Updated FPGA pin PROG_B connection. TPS3805H33 push-pull output RESET_N not affected on baseboard circuit, connected to PROG_B.
- 4. C8, C54, C56 updated to 100uF for variant 50-2I
- 5. Added testpoints

Changes REV 02A (12.2018):

- 1. New FLASH memory U7 S25FL127SABMFV10

A

A

B

B

C

C

D

D

		Title: TE0714	
		A4	Number: 7 50-2IC6
Date: 2016-08-04		Copyright: Trenz Electronic GmbH / TT	
Date: 2016-08-04		Page 7 of 7	
Filename: Revision Changes.SchDoc			

1

2

3

4