

U_B2B_Connectors
B2B_Connectors.SchDoc

U_xmod
xmod.SchDoc

U_SFP
SFP.SchDoc

Mount.Hole 3.2mm

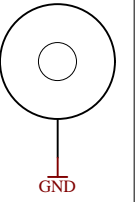

Micro USB2.0 B Receptacle 90° SMD/THT

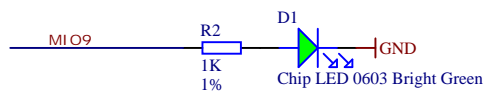
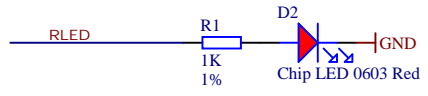
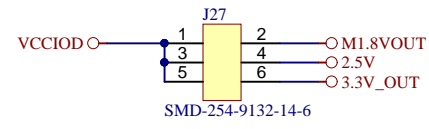
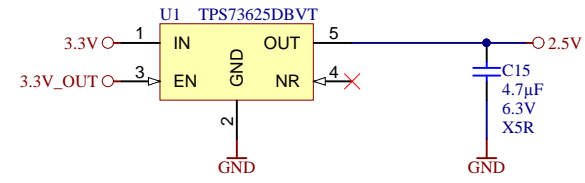
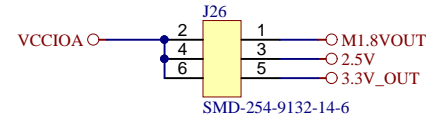
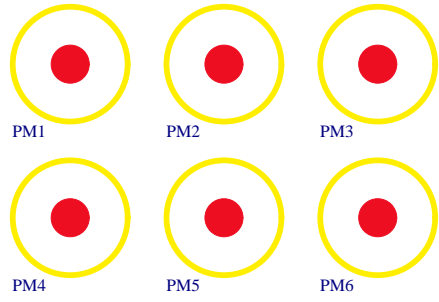
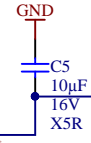
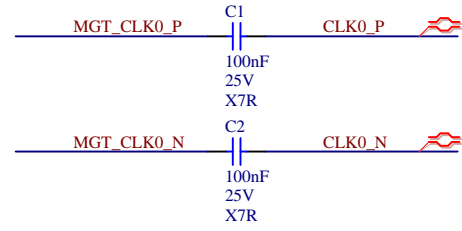
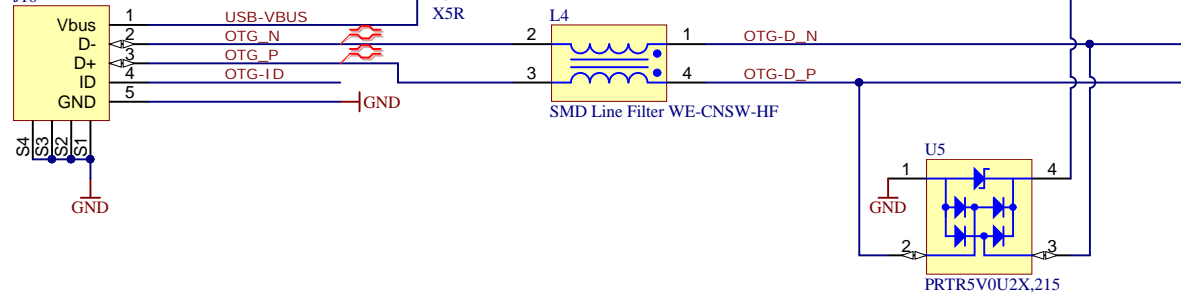
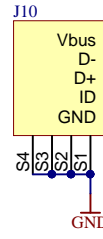

LOGO1
TE Logo PRINT Layer
LOGO PRINT

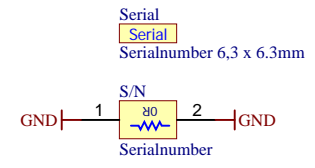

		Title: TEBA0841	
		A4	Number: TEBA0841 default
Date: 2016-06-13		Copyright: Trenz Electronic GmbH	
Filename: TEBA0841.SchDoc		Page1 of 4	

A

B

C

D

A

B

C

D

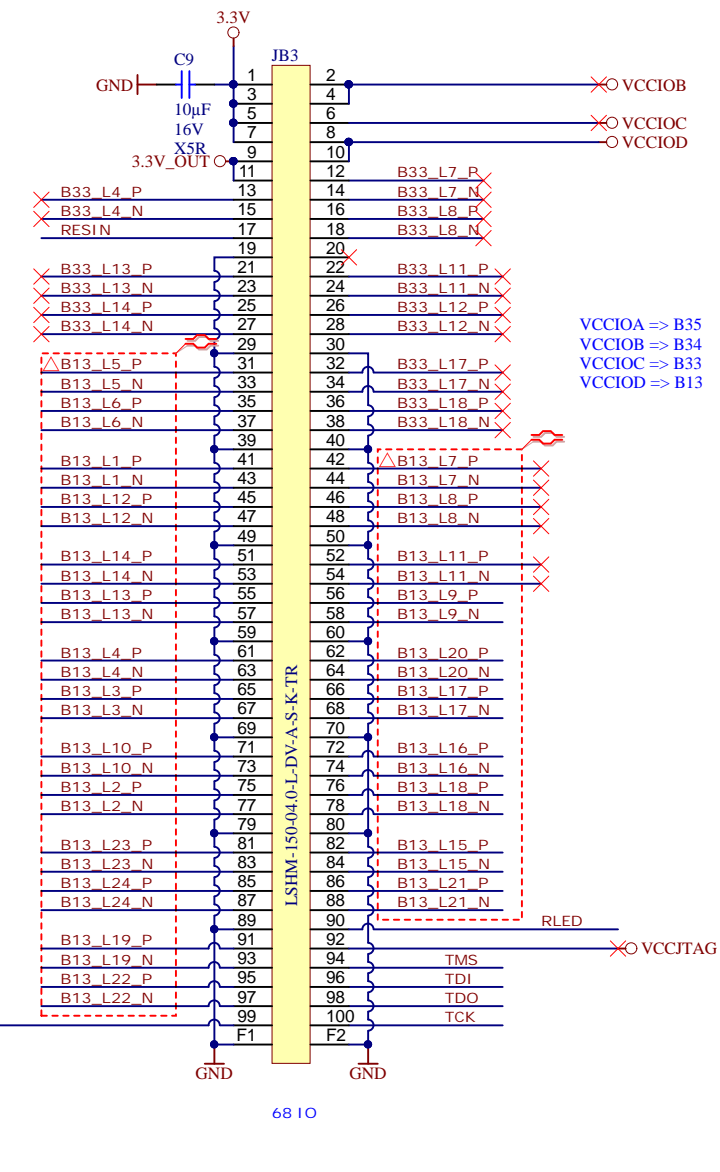
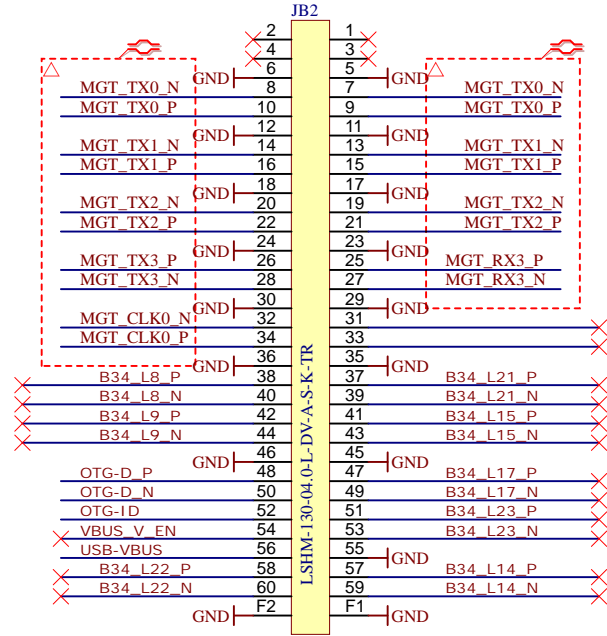
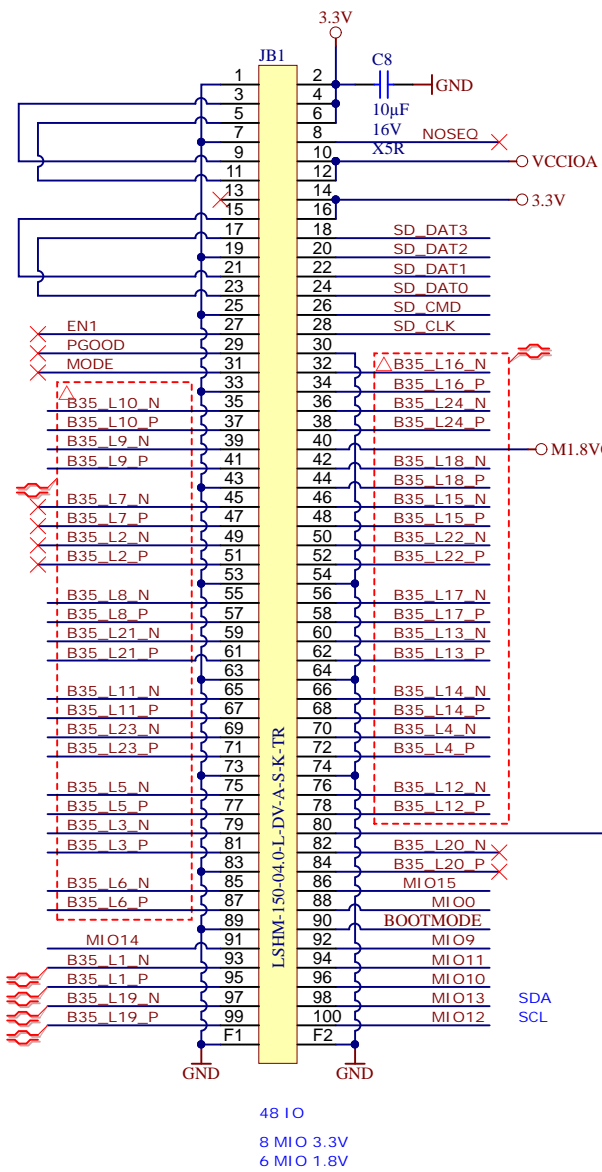

VCCIOA => B35
VCCIOB => B34
VCCIOC => B33
VCCIOD => B13



Title: TEBA0841 - B2B Connector		
A4	Number: TEBA0841 default	Rev. 01
Date: 2016-06-23	Copyright: Trenz Electronic GmbH	Page2 of 4
Filename: B2B_Connectors.SchDoc		

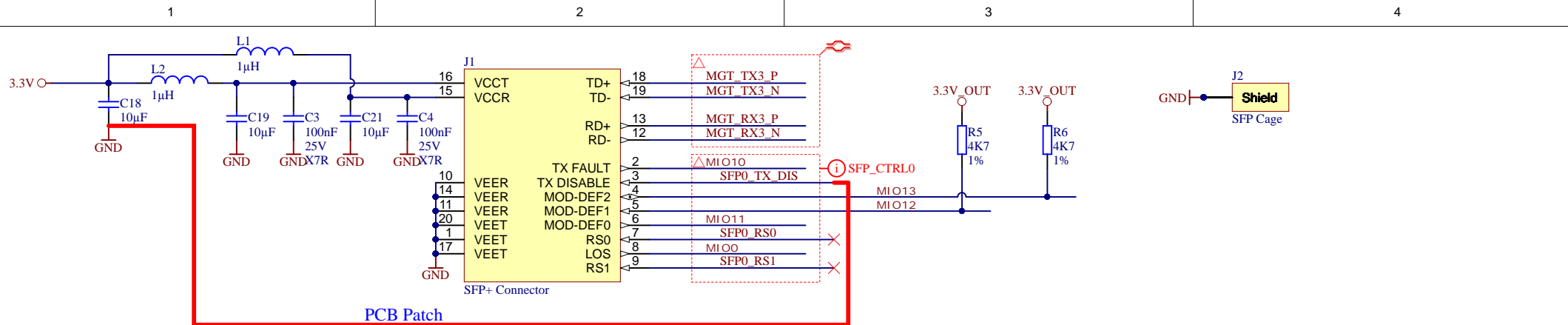

		Title: TEBA0841 - SFP	
		A4	Number: TEBA0841 default
Date: 2016-06-13		Copyright: Trenz Electronic GmbH / TT	
Filename: SFP.SchDoc		Page 3 of 4	

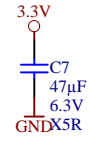
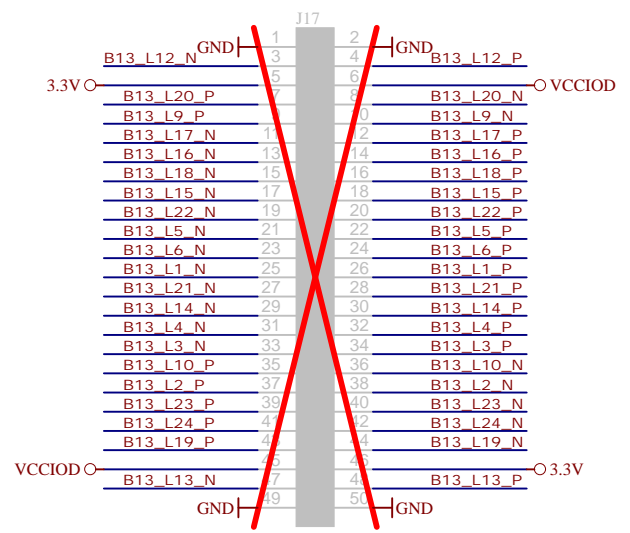
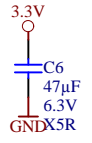
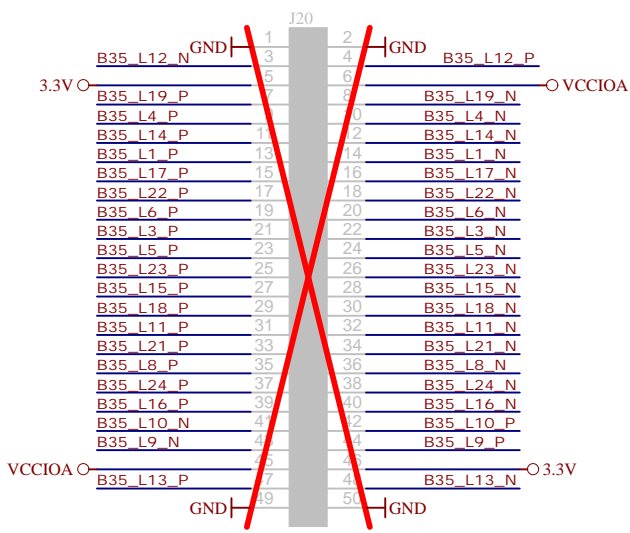

XMOD-FT2232H header: JTAG and UART

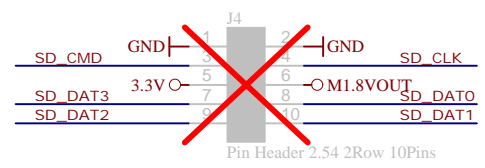
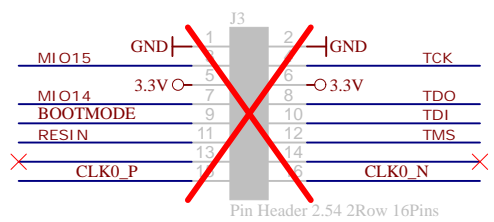
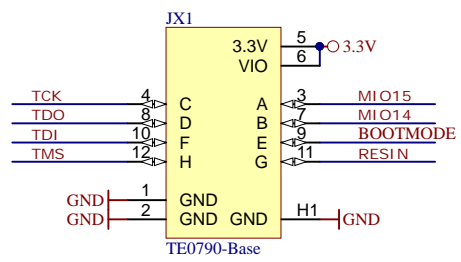

	Title: TEBA0841 - XMOD		
	A4	Number: TEBA0841 default	Rev. 01
	Date: 2016-06-13	Copyright: Trenz Electronic GmbH / TT	Page 4 of 4
	Filename: xmod.SchDoc		