

U_B2B_Connectors
B2B_Connectors.SchDoc

U_xmod
xmod.SchDoc

U_SFP
SFP.SchDoc

Mount.Hole 3.2mm

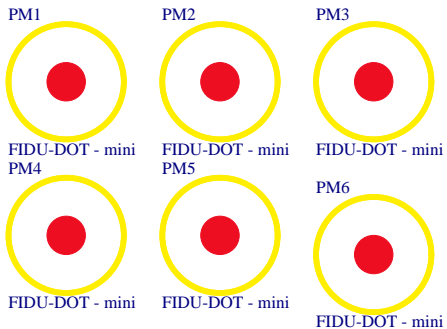

Micro USB2.0 B 90°

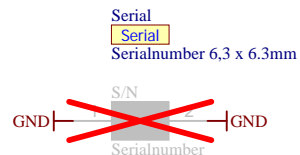
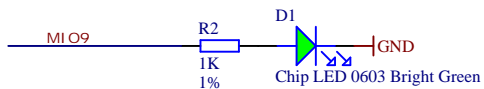
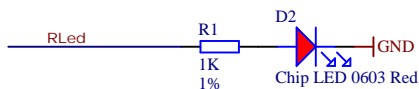
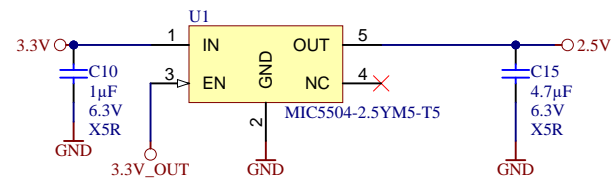
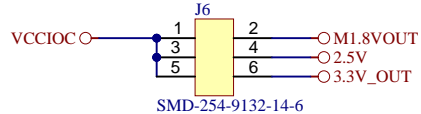
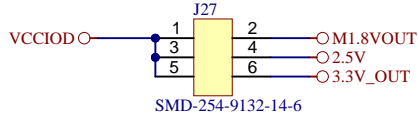
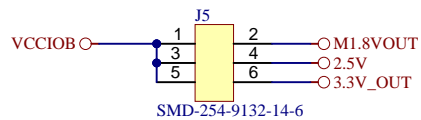
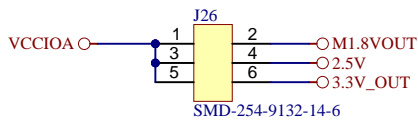
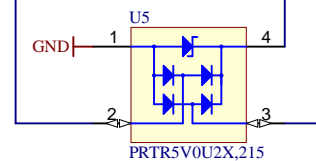
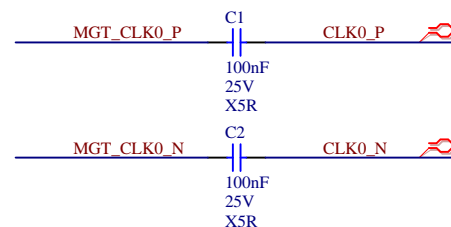
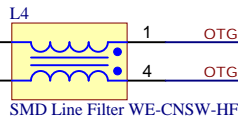
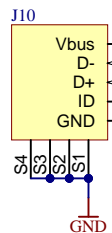

LOGO1
TE Logo PRINT Layer

LOGO PRINT



Title: TEBA0841		
A4	Number: TEBA0841 default	Rev. 02
Date: 2018-03-12	Copyright: Trenz Electronic GmbH	Page1 of 4
Filename: TEBA0841.SchDoc		

A

B

C

D

A

B

C

D

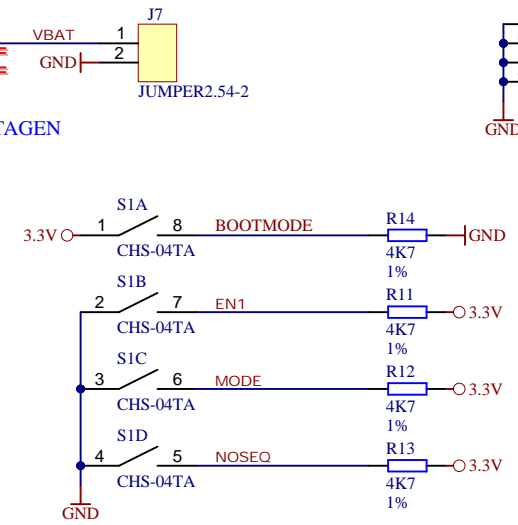
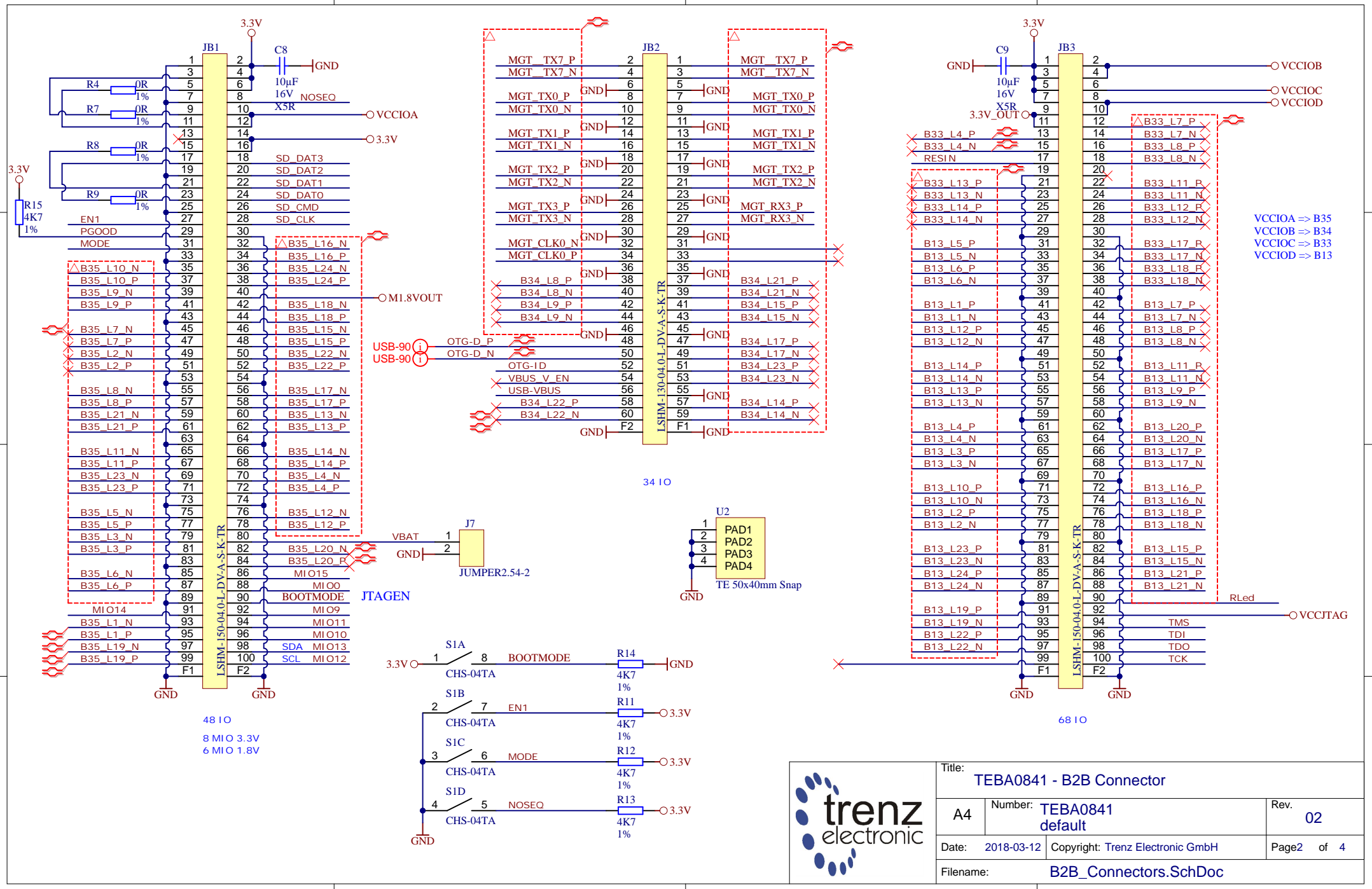

Title: TEBA0841 - B2B Connector		
A4	Number: TEBA0841 default	Rev. 02
Date: 2018-03-12	Copyright: Trenz Electronic GmbH	Page2 of 4
Filename: B2B_Connectors.SchDoc		

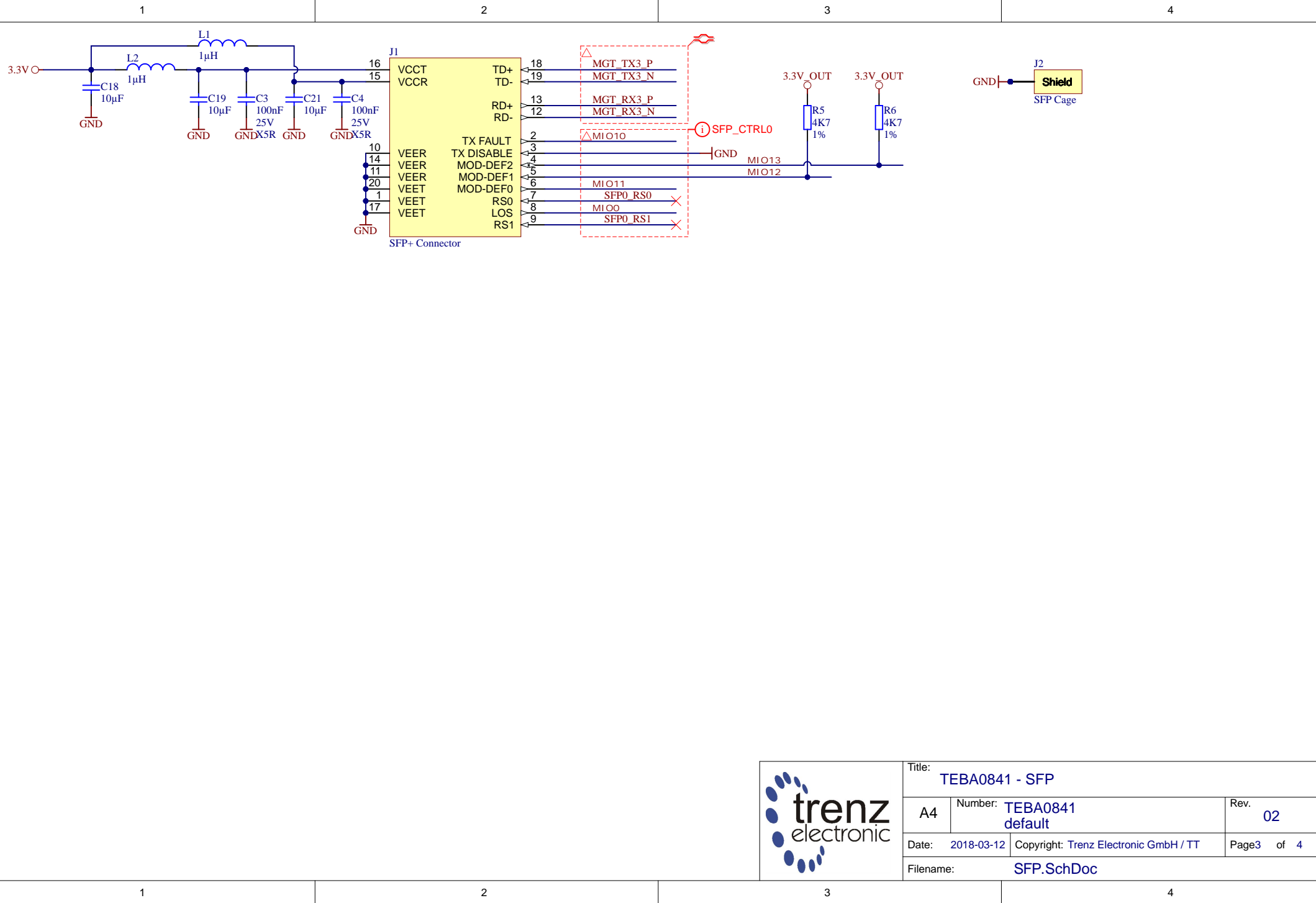

	Title: TEBA0841 - SFP		
	A4	Number: TEBA0841 default	Rev. 02
	Date: 2018-03-12	Copyright: Trenz Electronic GmbH / TT	Page3 of 4
	Filename: SFP.SchDoc		

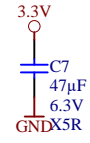
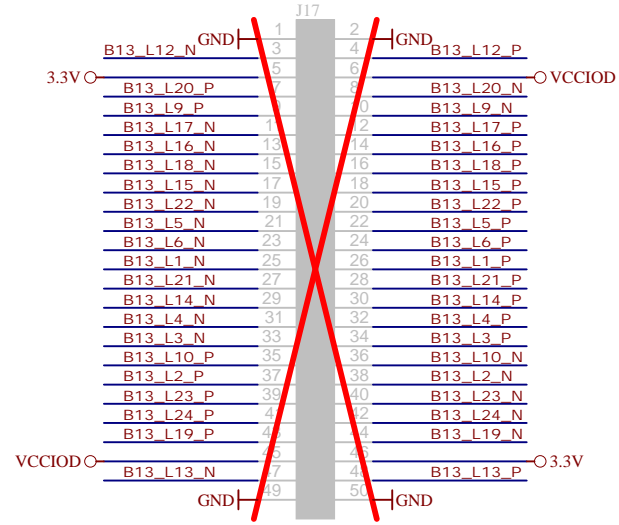
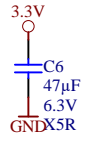
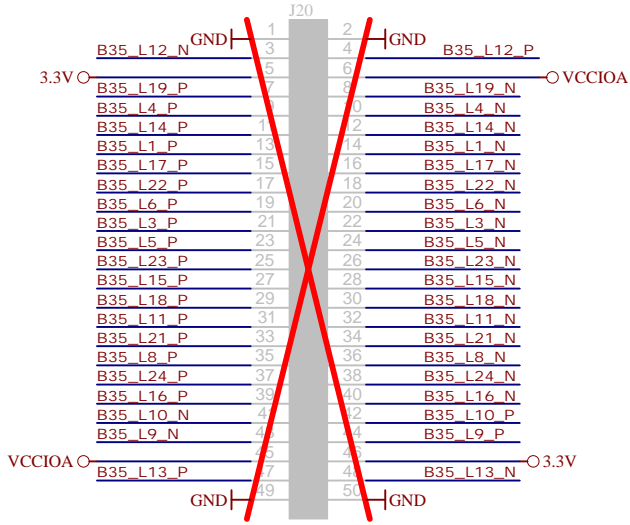

XMOD-FT2232H header: JTAG and UART

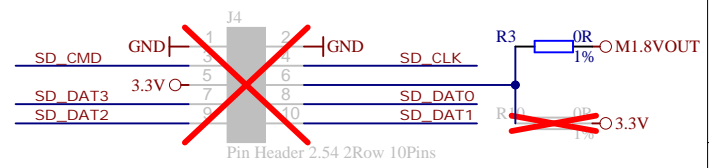
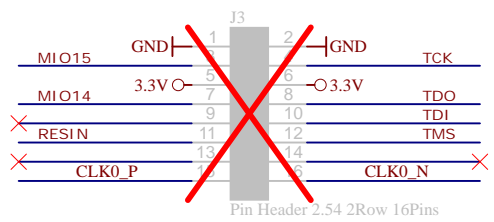
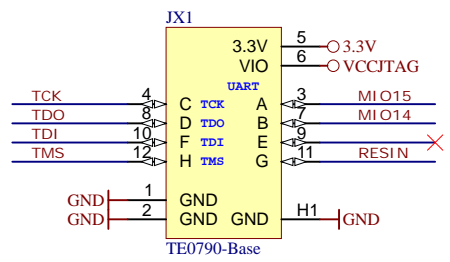

	Title: TEBA0841 - XMOD	
	A4	Number: TEBA0841 default
	Date: 2018-03-12	Copyright: Trenz Electronic GmbH / TT
	Filename: xmod.SchDoc	
	Rev. 02	Page 4 of 4