

Variant name: TE0710-03-42C21-A

Top View

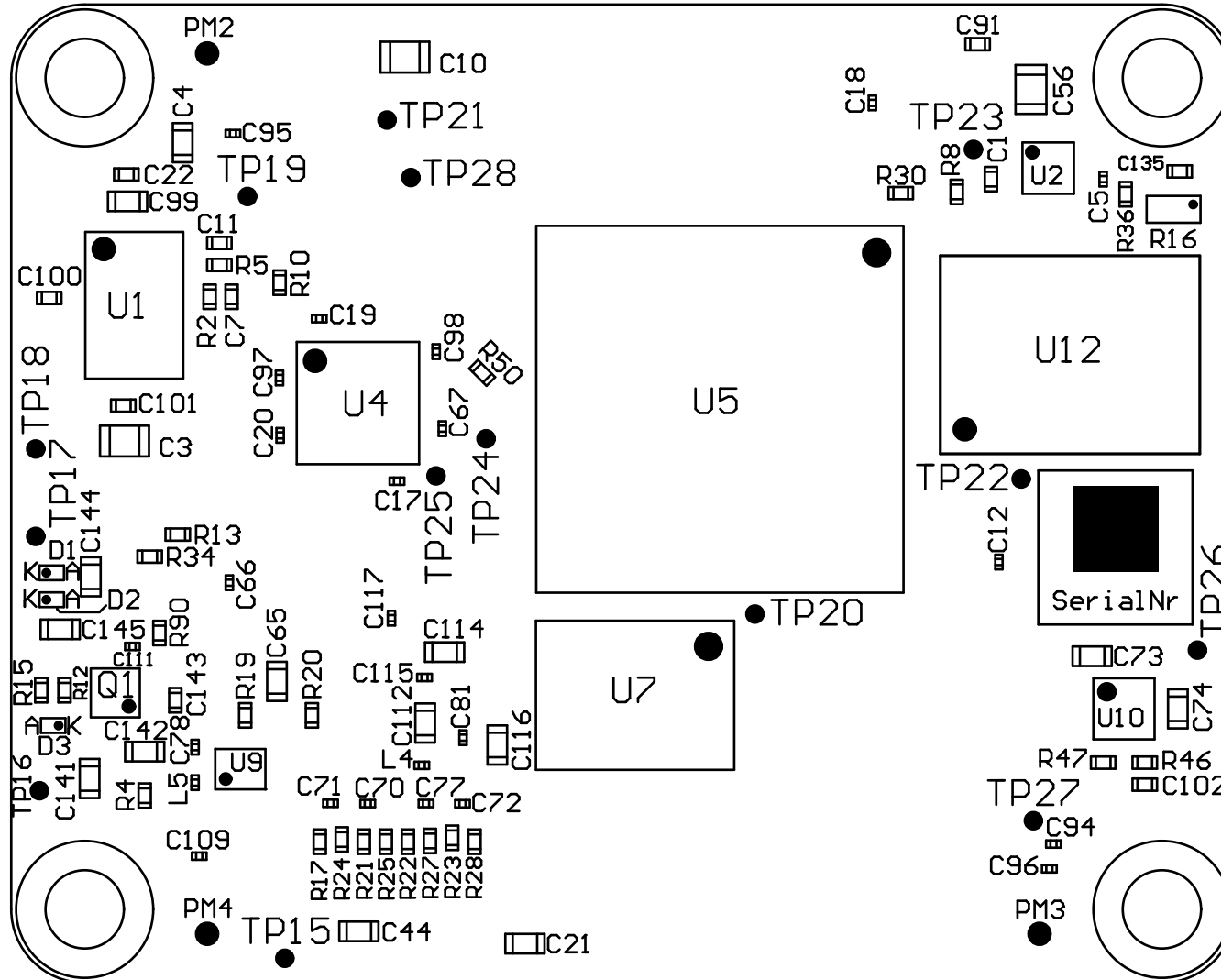

Variant name: TE0710-03-42C21-A

Bottom View

