

U_B12 B12.SchDoc
U_B13 B13.SchDoc
U_B14 B14.SchDoc
U_B15 B15.SchDoc
U_B16 B16.SchDoc
U_B34 B34.SchDoc

U_FPGA-MGT FPGA-MGT.SchDoc
U_FPGA-CFG FPGA-CFG.SchDoc
U_FPGA-MISC FPGA-MISC.SchDoc
U_FPGA-PWR FPGA-PWR.SchDoc

U_PWR1 PWR1.SchDoc
U_PWR2 PWR2.SchDoc

U_Clock Clock.SchDoc
-------------------------

U_B2B-Connectors B2B-Connectors.SchDoc
---

U_B33 B33.SchDoc
---------------------

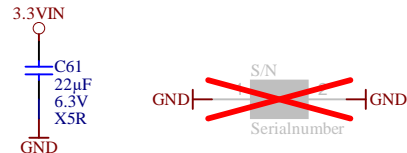
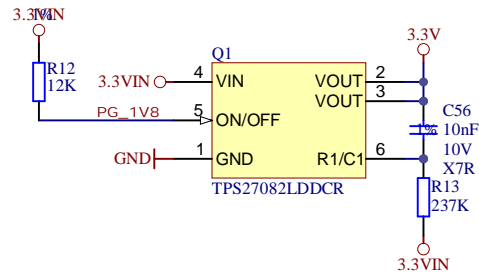
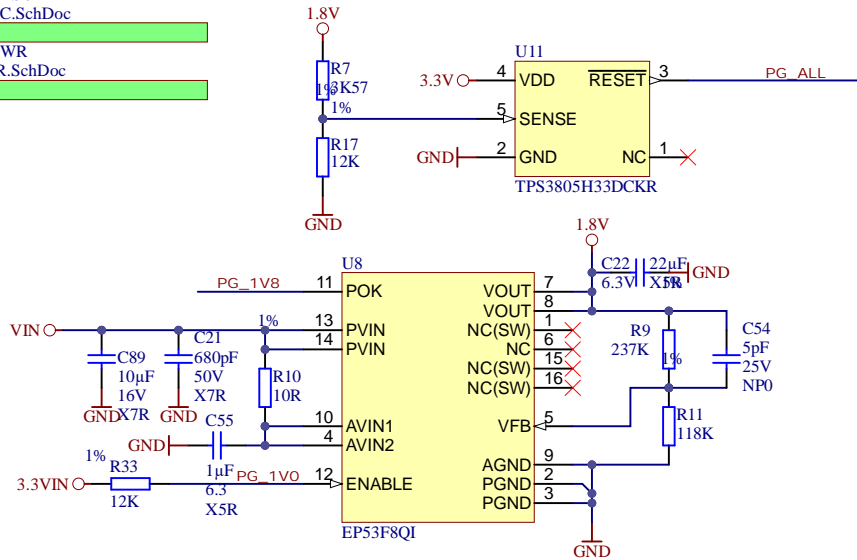
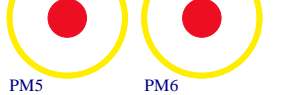
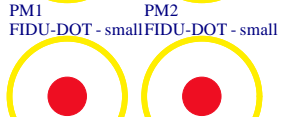
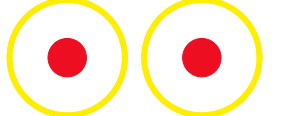
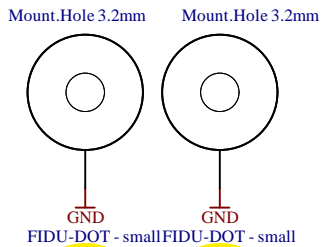
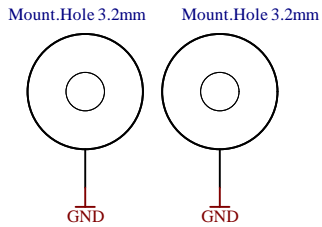

Serial  
Serial  
Serialnumber 6,3 x 6,3mm

Top of Board

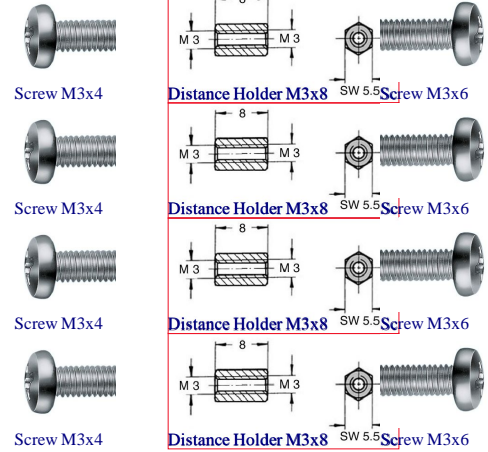

Assembly variant	160-2C1
Created by	VT
Modified by	VT
Modified at	2017-01-23
SVN Revision	8679

	Title: TE0741	
	A4	Number: TE0741 160-2C1
	Date: 2016-10-25	Copyright: 2013 Trenz Electronic GmbH
	Page 1 of 17	Rev. 03
Filename: TE0741.SchDoc		

1

2

3

4

B13 48 IO, 24 LVDS Pairs  
 B14 8 IO, 3.3V  
 MGT 3 Lanes

B16 16 IO, 8 LVDS Pairs  
 MGT 4 + 1 Lanes  
 B14 4 IO, 3.3V

B15 18 IO, 9 LVDS Pairs  
 B12 48 IO, 24 LVDS Pairs  
 B12 2 IO

A

A

B

B

C

C

D

D

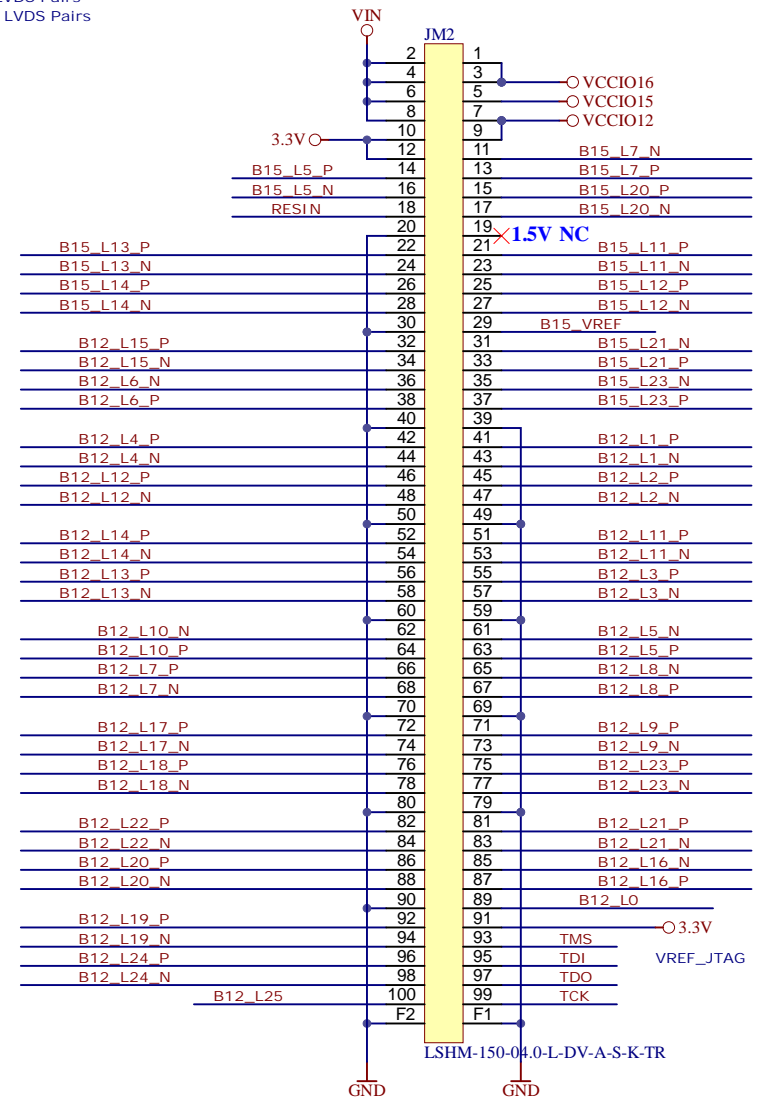
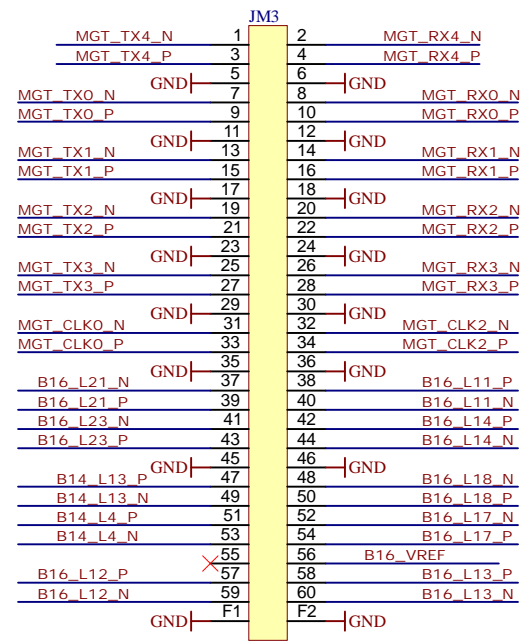
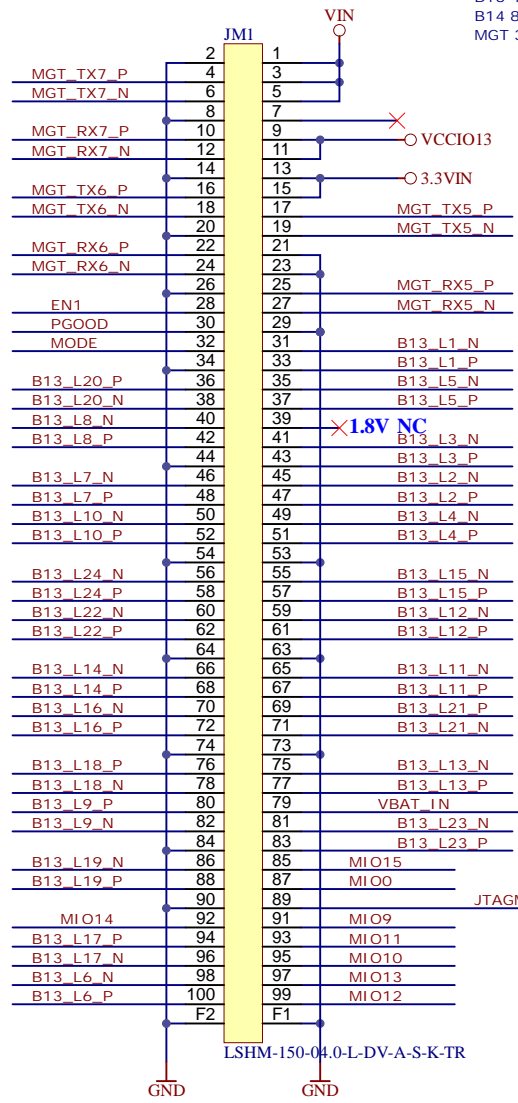

TE0720 Compatibility

MIO0 8 pins => 8 IO B14  
 USB D+,D-, vbusen,otg\_id => 4 IO B14  
 SGMII => MGT  
 MIO1(SDCARD) => MGT  
 ETH MD1 => MGT  
 B34 => B16, MGT  
 B35 => B13  
 B13 => B12  
 B33 => B15

Clock Capable I/O  
 All pins named  
 Bxx\_11\_X  
 Bxx\_12\_X  
 Bxx\_13\_X  
 Bxx\_14\_X  
 Are Clock Capable I/O's



Title: TE0741		
A4	Number: TE0741 160-2C1	Rev. 03
Date: 2016-10-25	Copyright: 2013 Trenz Electronic GmbH	Page2 of 17
Filename: B2B-Connectors.SchDoc		

1

2

3

4

B12\_FIXED (i) △

B12_L11_P
B12_L11_N
B12_L12_P
B12_L12_N
B12_L13_P
B12_L13_N
B12_L14_P
B12_L14_N
B12_L19_P
B12_L19_N
B12_L6_P
B12_L6_N

**K70T version does not have this bank!**

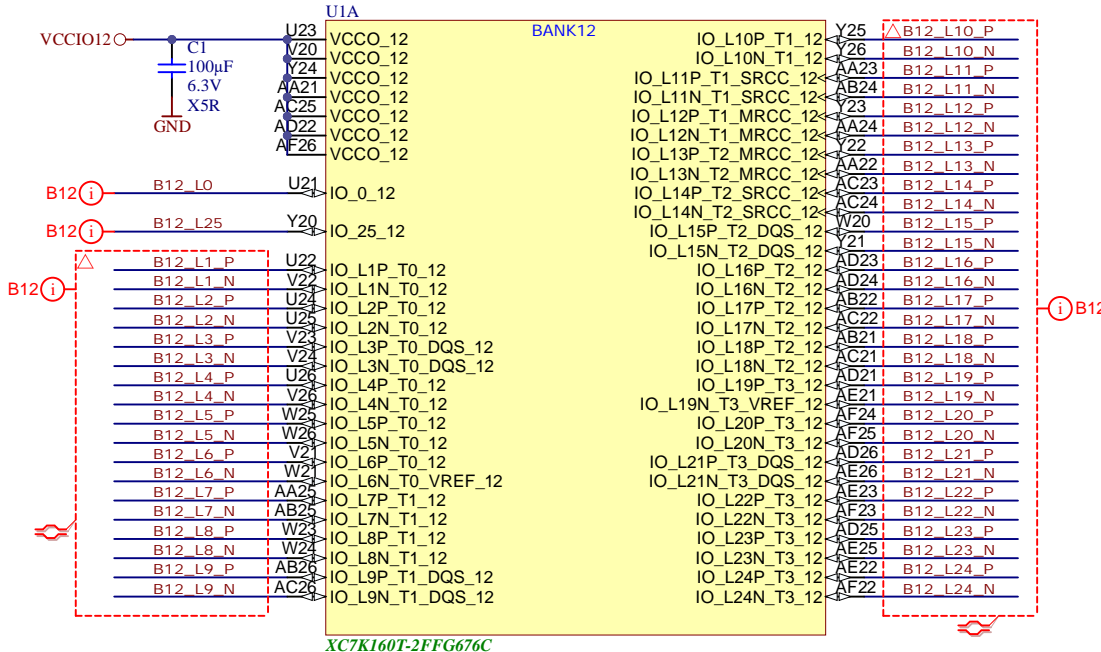

XC7K160T-2FFG676C

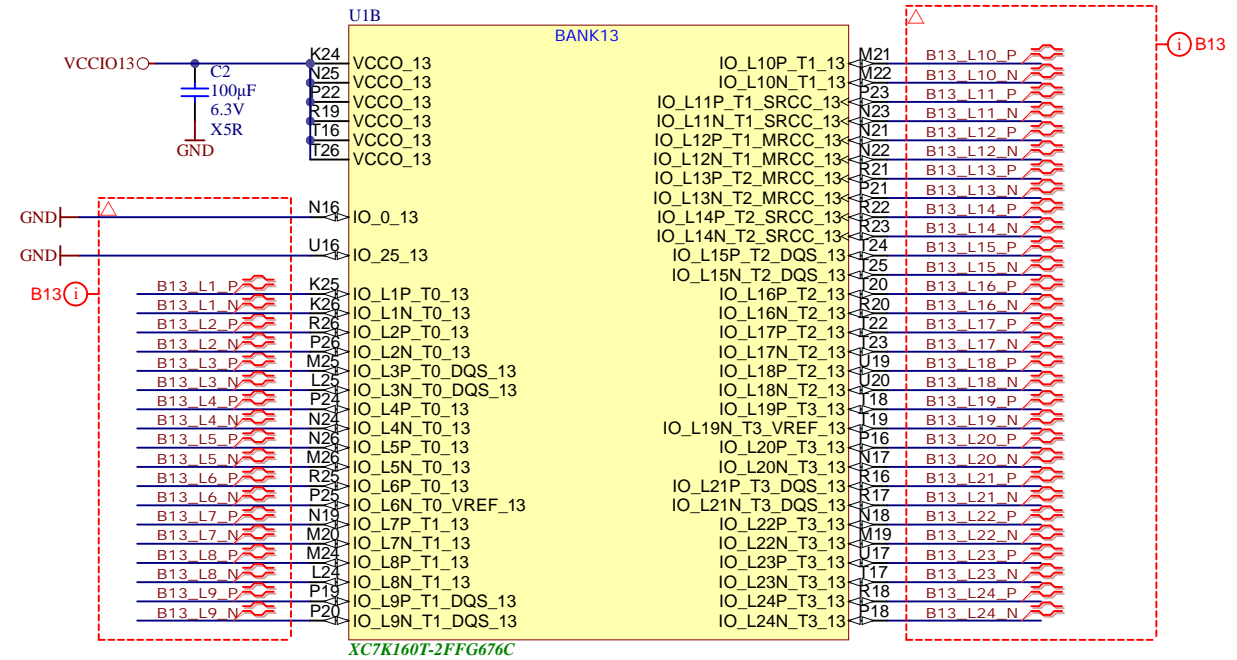
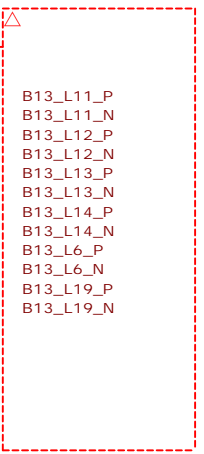

	Title: TE0741	
	A4	Number: TE0741 160-2C1
	Date: 2016-10-25	Rev. 03
	Copyright: 2013 Trenz Electronic GmbH	Page3 of 17
Filename: B12.SchDoc		

B13\_FIXED (i)

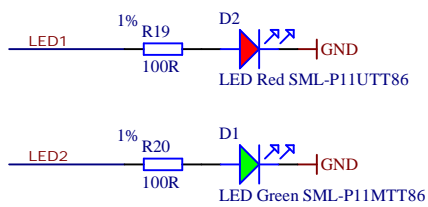
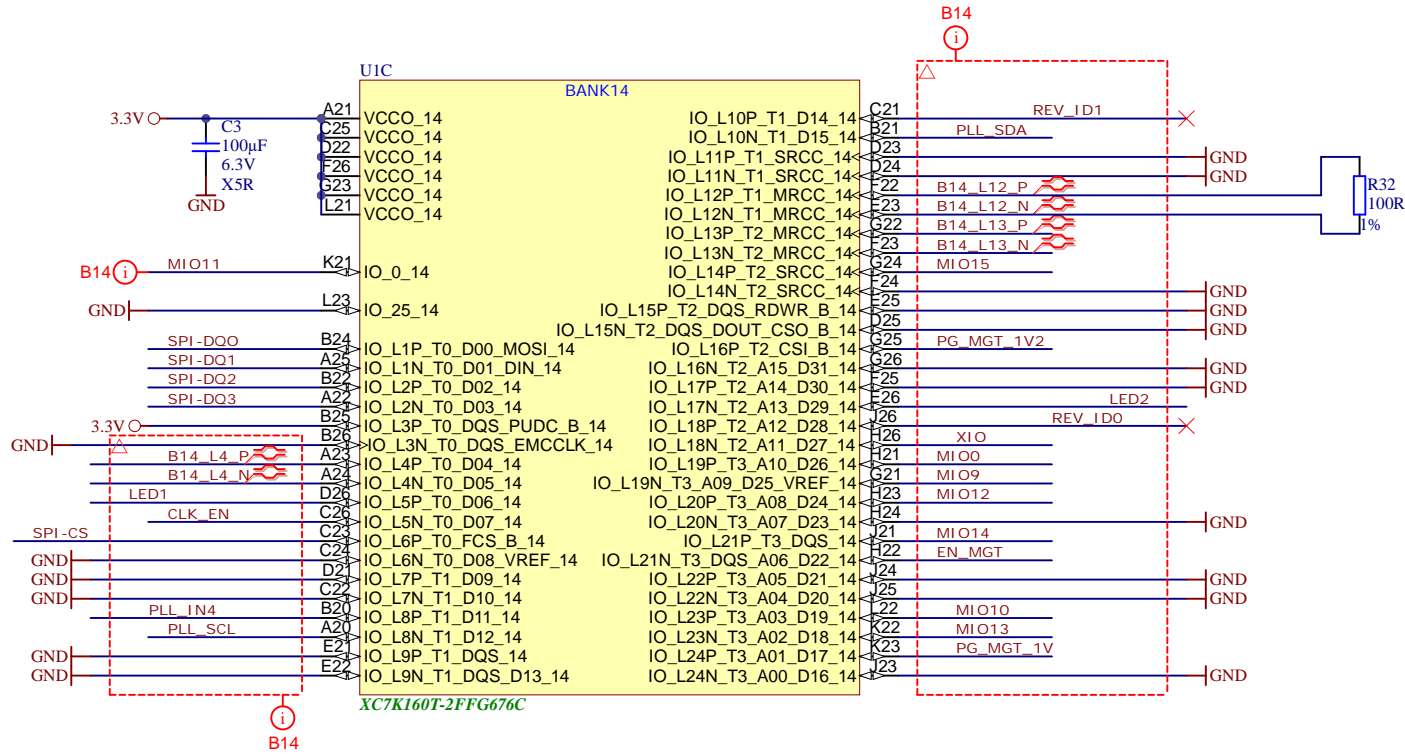

XC7K160T-2FFG676C

	Title: <b>TE0741</b>		
	A4	Number: <b>TE0741 160-2C1</b>	Rev. <b>03</b>
	Date: <b>2016-10-25</b>	Copyright: <b>2013 Trenz Electronic GmbH</b>	Page <b>4</b> of <b>17</b>
	Filename: <b>B13.SchDoc</b>		

Title: TE0741		
A4	Number: TE0741 160-2C1	Rev. 03
Date: 2016-10-25	Copyright: 2013 Trenz Electronic GmbH	Page5 of 17
Filename: B14.SchDoc		

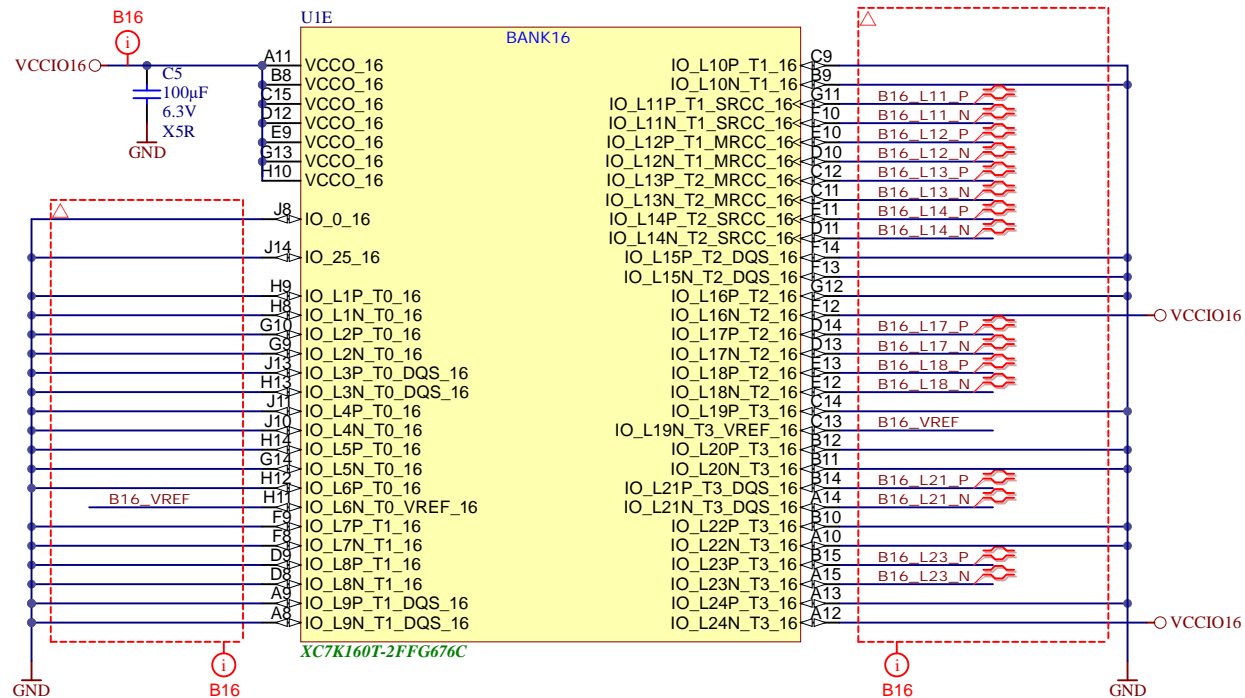

	Title: <b>TE0741</b>		
	A4	Number: <b>TE0741 160-2C1</b>	Rev. <b>03</b>
	Date: <b>2016-10-25</b>	Copyright: <b>2013 Trenz Electronic GmbH</b>	Page <b>6</b> of <b>17</b>
	Filename: <b>B16.SchDoc</b>		

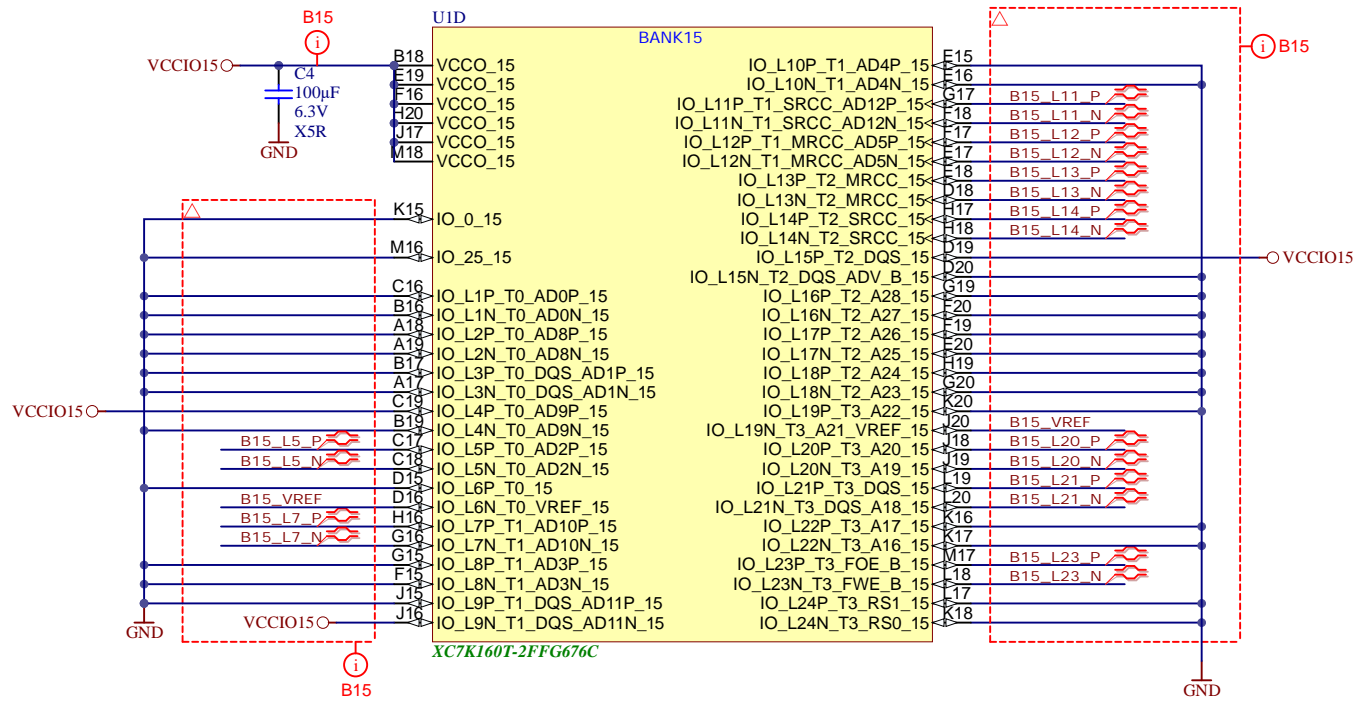

Title: <b>TE0741</b>		
A4	Number: <b>TE0741 160-2C1</b>	Rev. <b>03</b>
Date: <b>2016-10-25</b>	Copyright: <b>2013 Trenz Electronic GmbH</b>	Page <b>7</b> of <b>17</b>
Filename: <b>B15.SchDoc</b>		

UIF

BANK32

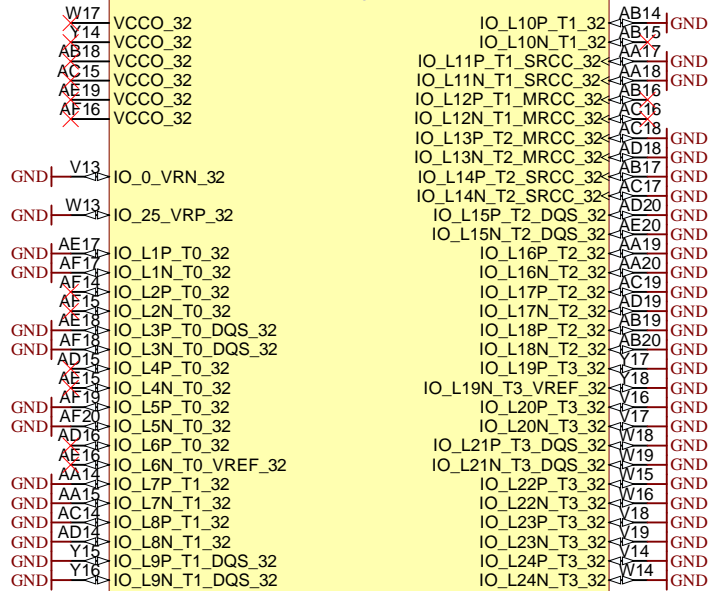

XC7K160T-2FFG676C

UIG

BANK33

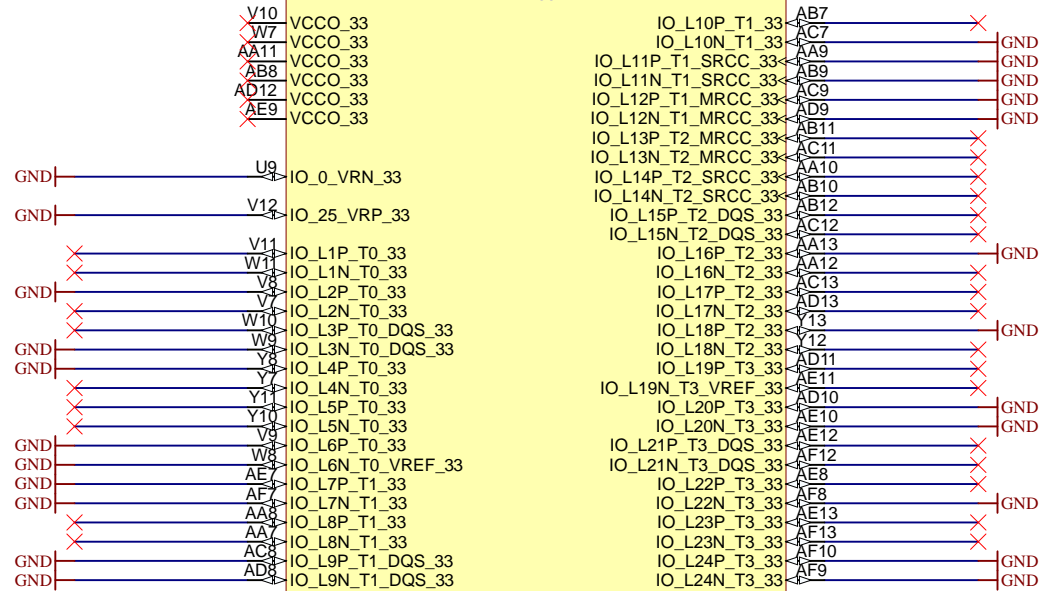



XC7K160T-2FFG676C



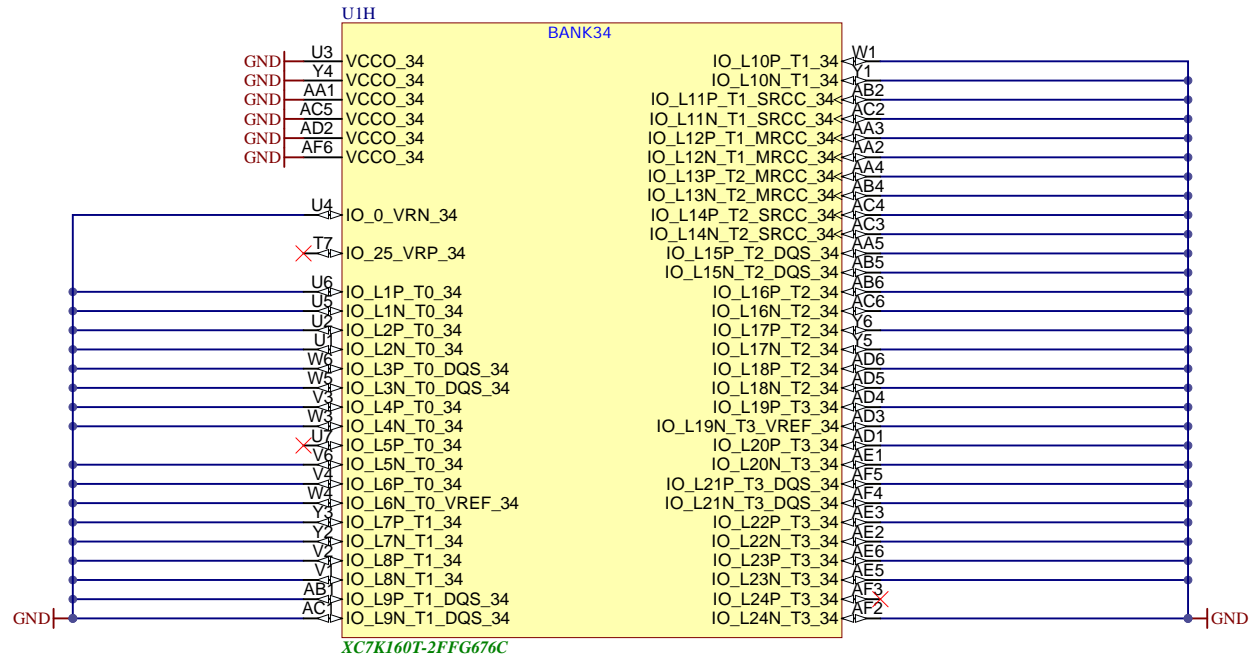

Title: TE0741		
A4	Number: TE0741 160-2C1	Rev. 03
Date: 2016-10-25	Copyright: 2013 Trenz Electronic GmbH	Page8 of 17
Filename: B33.SchDoc		



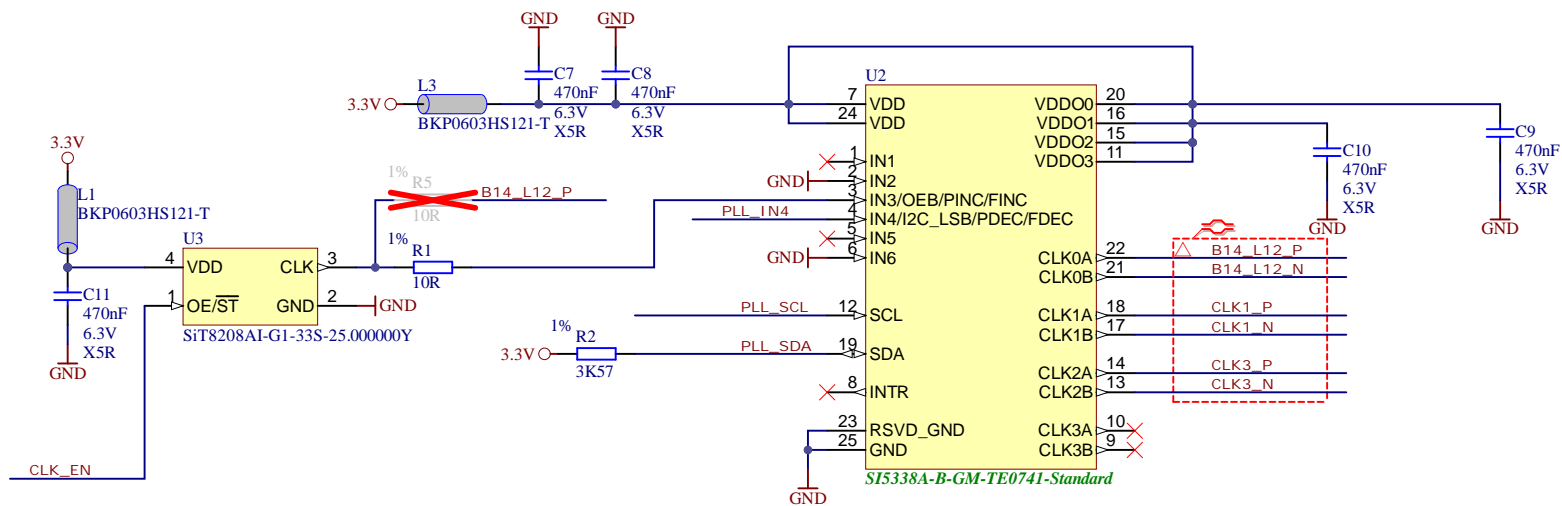

	Title: TE0741		
	A4	Number: TE0741 160-2C1	Rev. 03
	Date: 2016-10-25	Copyright: 2013 Trenz Electronic GmbH	Page9 of 17
	Filename: B34.SchDoc		



	Title: <b>TE0741</b>		
	A4	Number: <b>TE0741 160-2C1</b>	Rev. <b>03</b>
	Date: <b>2016-10-25</b>	Copyright: <b>2013 Trenz Electronic GmbH</b>	Page <b>10</b> of <b>17</b>
	Filename: <b>Clock.SchDoc</b>		

BOOTMODE = MASTER SPI => 0 0 1

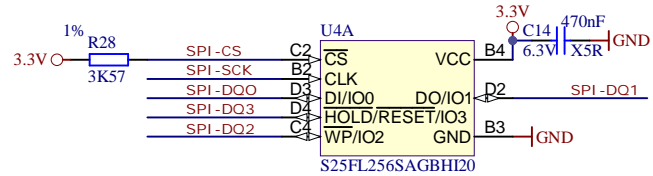
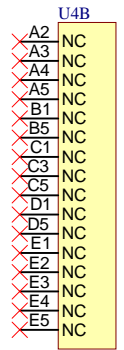
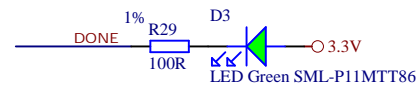
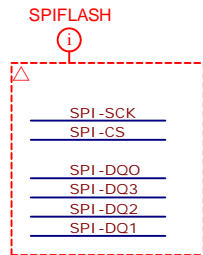
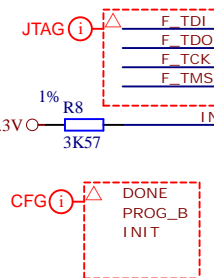
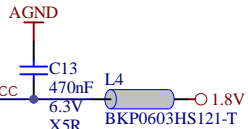
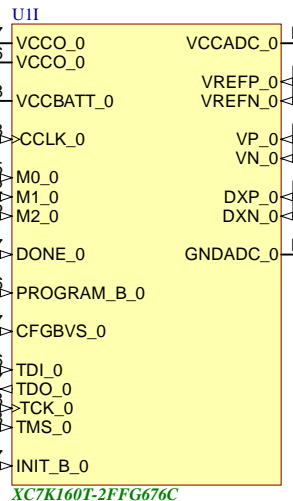

Title: TE0741		
A4	Number: TE0741 160-2C1	Rev. 03
Date: 2016-10-25	Copyright: 2013 Trenz Electronic GmbH	Page 11 of 17
Filename: FPGA-CFG.SchDoc		

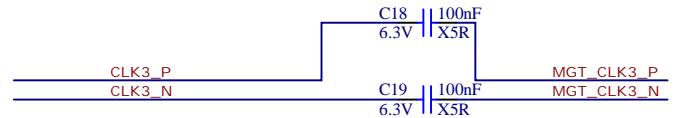
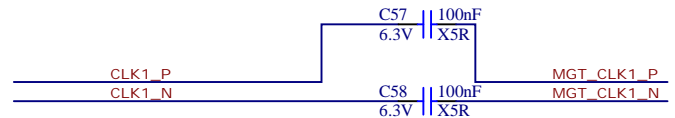
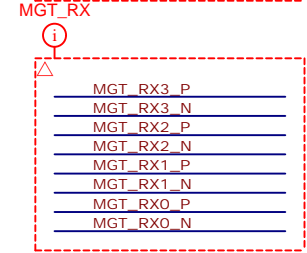
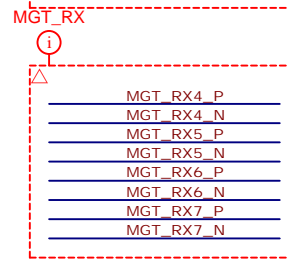
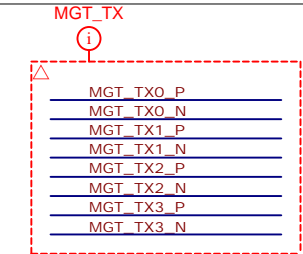
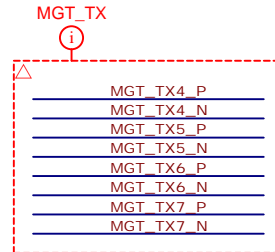
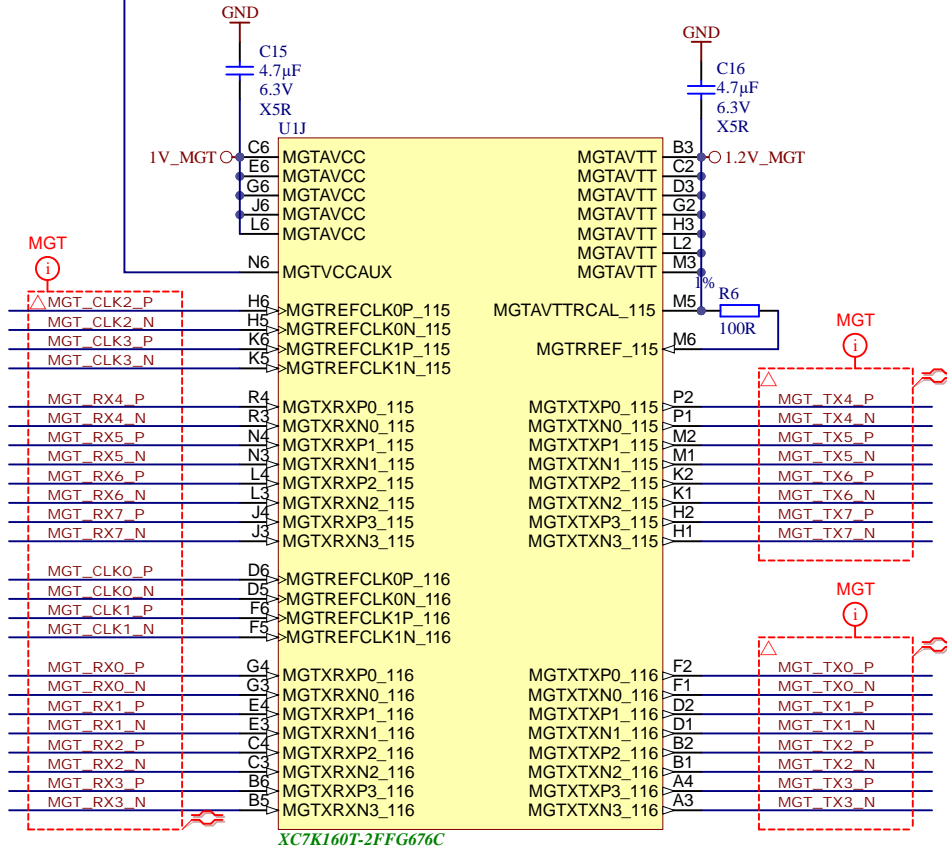
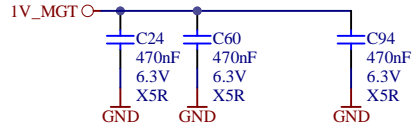
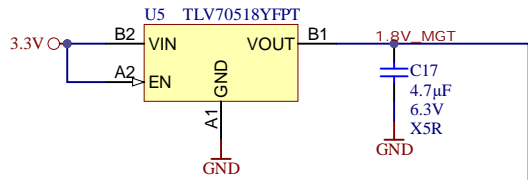

Title: TE0741		
A4	Number: TE0741 160-2C1	Rev. 03
Date: 2016-10-25	Copyright: 2013 Trenz Electronic GmbH	Page 12 of 17
Filename: FPGA-MGT.SchDoc		

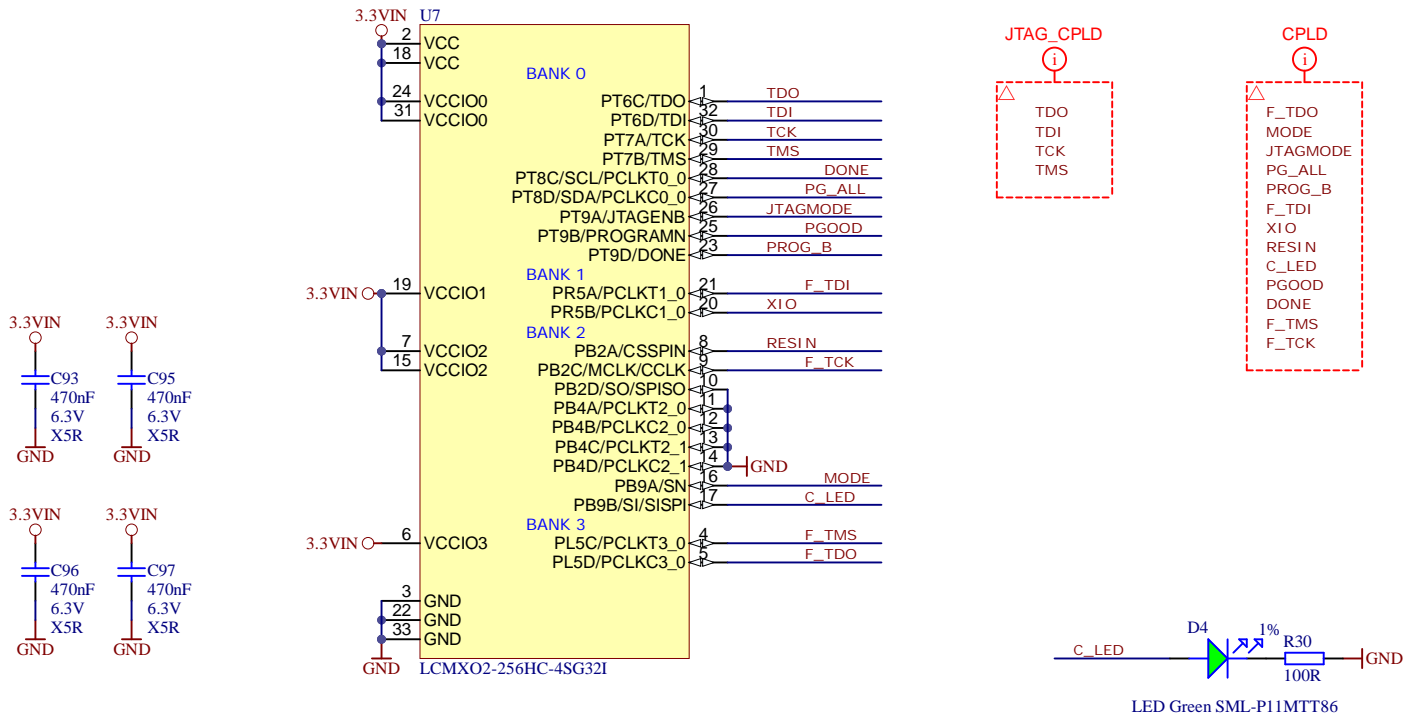

		Title: TE0741	
		A4	Number: TE0741 160-2C1
Date: 2016-10-25		Copyright: 2013 Trenz Electronic GmbH	
Page 13 of 17		Filename: FPGA-MISC.SchDoc	

1

2

3

4

A

A

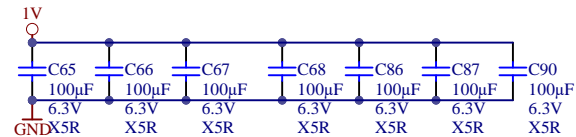
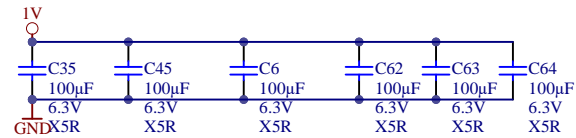
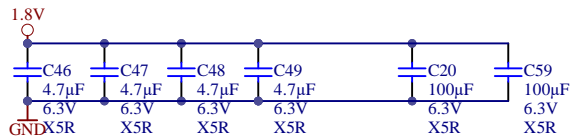
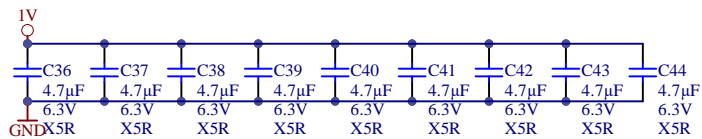
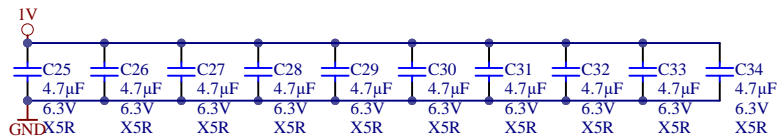

B

B

C

C

D

D

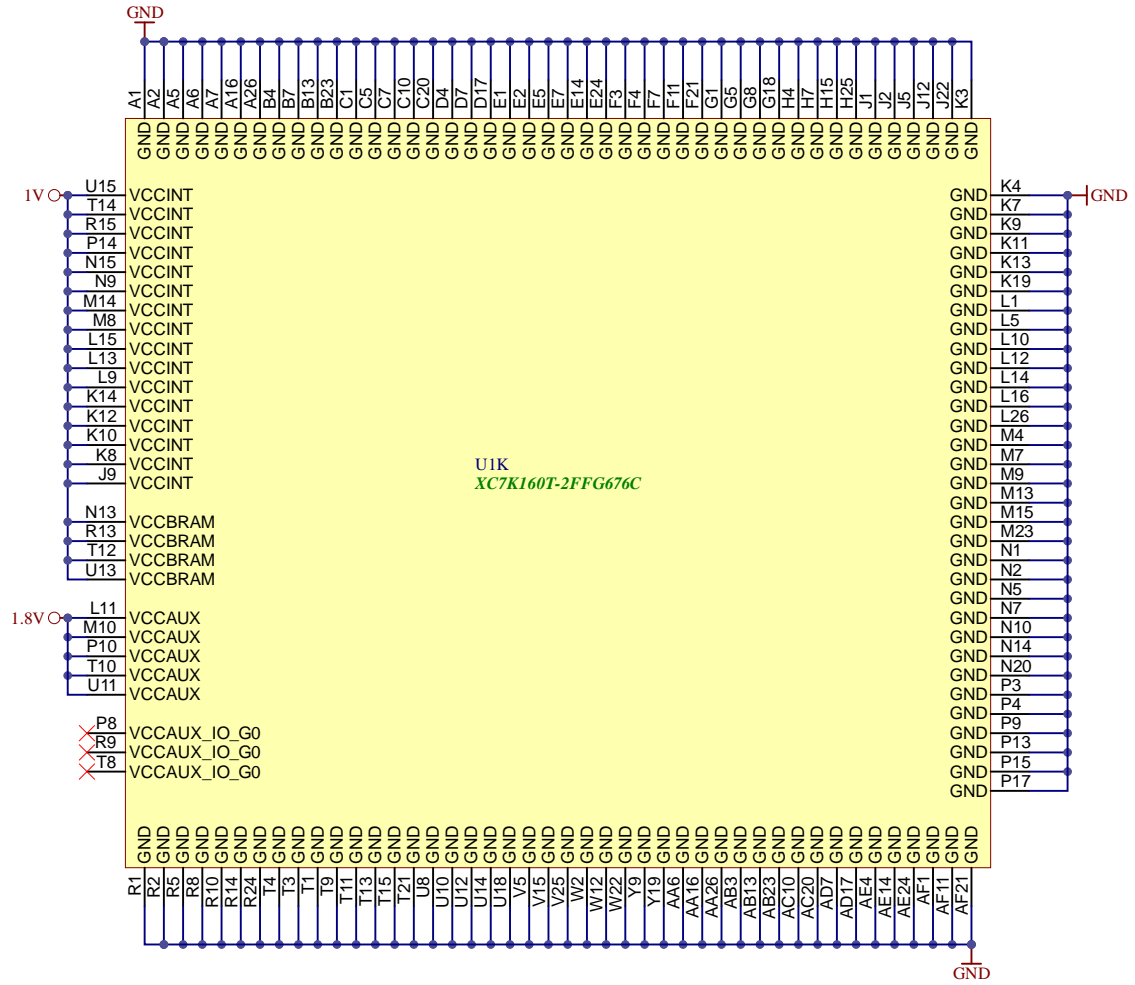

Title: TE0741		
A4	Number: TE0741 160-2C1	Rev. 03
Date: 2016-10-25	Copyright: 2013 Trenz Electronic GmbH	Page 14 of 17
Filename: FPGA-PWR.SchDoc		

1

2

3

4

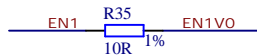
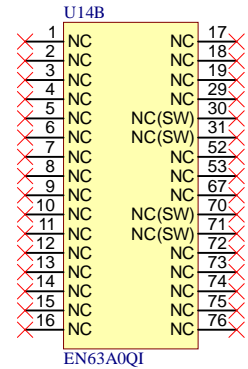
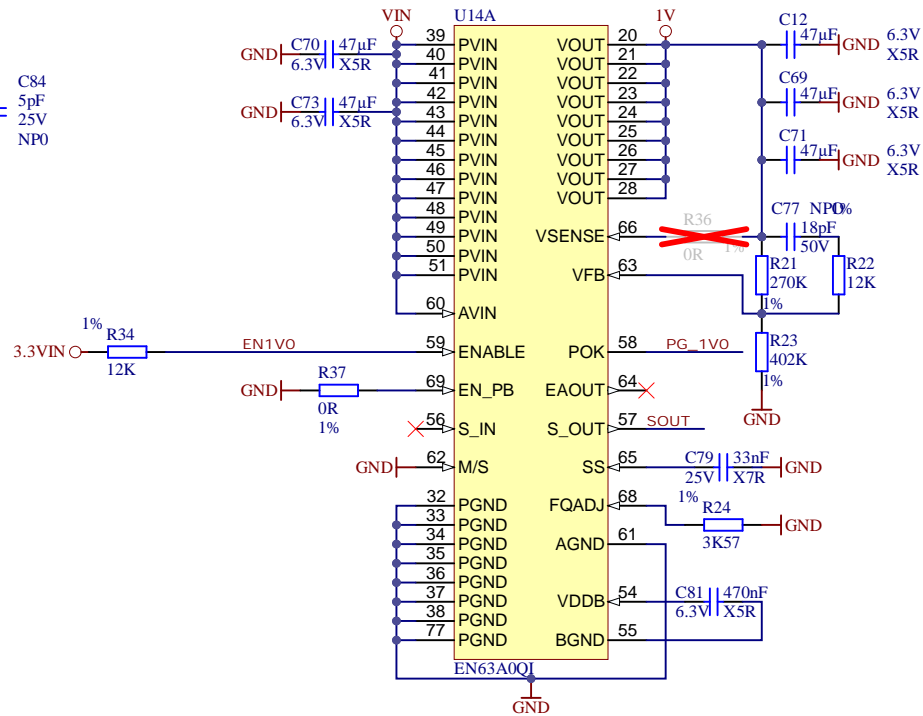
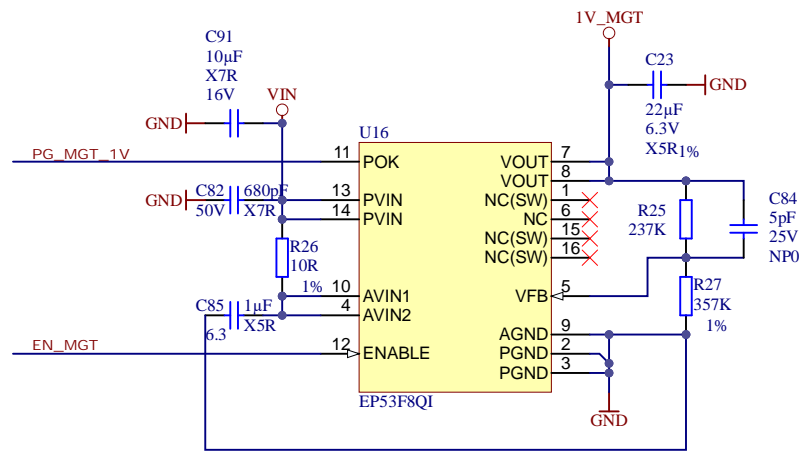

**A** Not mount if baseboard EN1 circuit cause problems

Pre-bias feature is not available for parallel operations

R36 R37 MODE EN63A0QI

OK X | enable pre-bias start-up (available when U14 or U15 as DNP )  
 X OK | disable pre-bias start-up

	Title: <b>TE0741</b>		
	A4	Number: <b>TE0741 160-2C1</b>	Rev. <b>03</b>
	Date: 2016-10-25	Copyright: 2013 Trenz Electronic GmbH	Page 15 of 17
	Filename: <b>PWR1.SchDoc</b>		

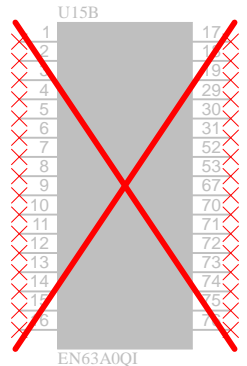
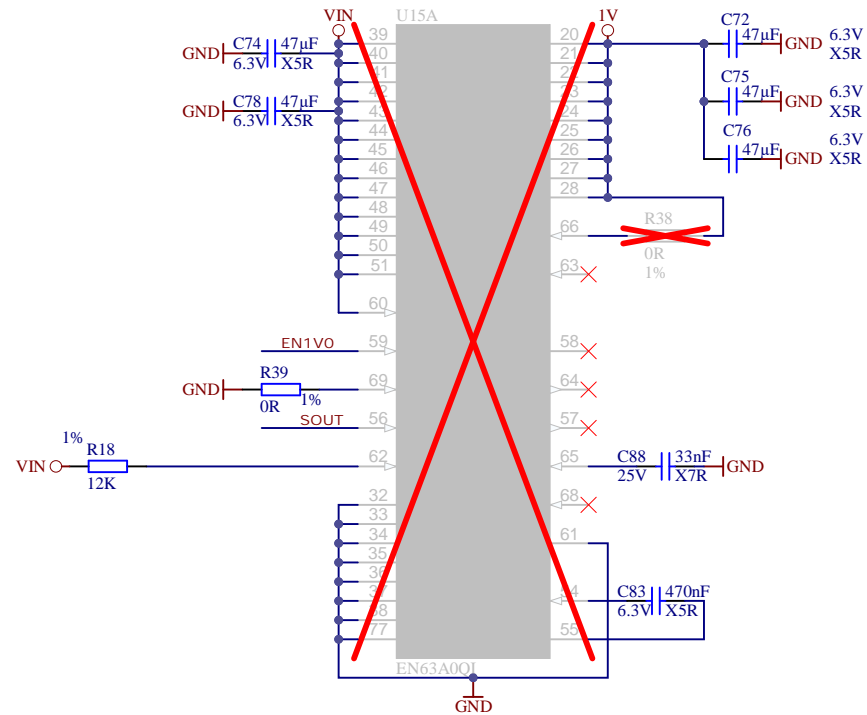
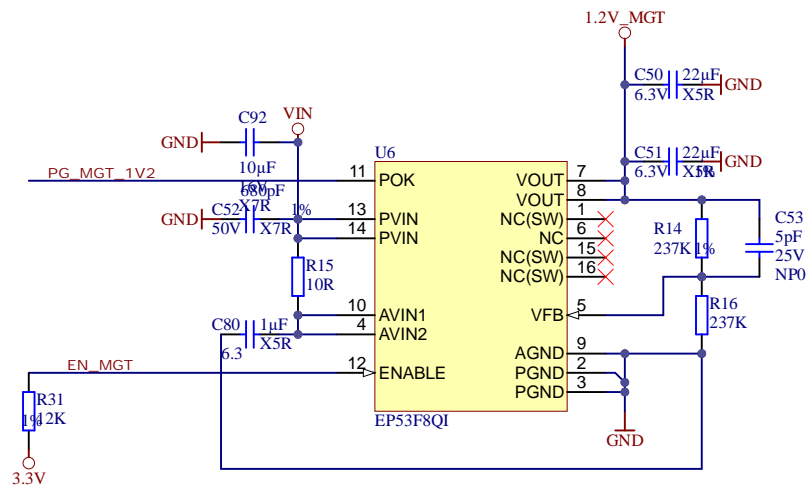

Pre-bias feature is not available for parallel operations

R38 R39 MODE EN63A0QI

-----  
 OK X | enable pre-bias start-up (available when U14 or U15 as DNP )  
 X OK | disable pre-bias start-up



Title: TE0741		
A4	Number: TE0741 160-2C1	Rev. 03
Date: 2016-10-25	Copyright: 2013 Trenz Electronic GmbH	Page 16 of 17
Filename: PWR2.SchDoc		



1

2

3

4

CHANGES REV02 to REV03

- 1) fixed connection DCDC for parallel operations
- 2) update Razorbeam Connectors, full update lib
- 3) added serial number (traceability pad)
- 4) changed ferrite beads L1..L4 size 0402 on BKP0603HS121-T
- 5) added thermal vias to mounting holes

A

A

B

B

C

C

D

D

	Title: <b>TE0741 - Changes list</b>		
	A4	Number: <b>TE0741 160-2C1</b>	Rev. <b>03</b>
	Date: <b>2016-10-25</b>	Copyright: <b>Trenz Electronic GmbH</b>	Page <b>17</b> of <b>17</b>
	Filename: <b>Revision_Changes.SchDoc</b>		

1

2

3

4