



Regarding the usage of our schematics and alike documentation for Trenz module TE0741.

Project is protected under copyright and we strongly and strictly prohibit the reverse engineering or recreation, even if the design is just adapted or modified. TE0741 is protected under such right and in case of plagiarism we will have to do anything necessary in order to protect our assets.

Schematics and other handouts serve for informational purposes only!

	Title: <b>TE0741 - Legal Notices Modules</b>		
	A4	Number: <b>TE0741 G2C-1-A</b>	Rev. <b>05</b>
	Date: <b>2023-08-02</b>	Copyright: <b>Trenz Electronic GmbH</b>	Page <b>1</b> of <b>20</b>
	Filename: <b>Legal Notices Modules.SchDoc</b>		

REV	Description	
-01	Initial revision	
-02		
-03	<ul style="list-style-type: none"> <li>1) fixed connection DCDC for parallel operations</li> <li>2) update Razorbeam Connectors, full update lib</li> <li>3) added serial number (traceability pad)</li> <li>4) changed ferrite beads L1..L4 size 0402 on BKP0603HS121-T</li> <li>5) added thermal vias to mounting holes</li> </ul>	VT
-04	<ul style="list-style-type: none"> <li>1) replaced all DCDC (reason: not recommended use Enpirion DCDC)</li> <li>2) remove Traceability Pad (reason: EOL)</li> <li>3) added additional resistor for VBAT (reason: possibility using external VBAT from Carrier Board)</li> <li>4) full upd LIB components</li> <li>5) optimization PCB routing</li> </ul>	VT
-05	<ul style="list-style-type: none"> <li>1) Added PULLUP R34 for net EN1</li> <li>2) Added PULLUP R43 for net PROG_B</li> <li>3) Changed component Q1 (TPS27081ADDCR) to U17(MP5077GG-Z)</li> <li>4) Added external compensation for U14-U15 (2 LTM4638 in parallel mode)</li> <li>5) Added diode between nets INIT and PROG_B</li> <li>6) Removed power supervisor TPS3805H33DCKR. Added power sense monitor U11 STM6710LWB6F</li> <li>7) Updated Overview</li> <li>8) Updated Power diagram</li> <li>9) Some nets from banks 32, 33, 34 were connected to GND for increasing ESD protection</li> <li>10) Added PullUp resistor R49 for net CLK_EN on page 18</li> <li>11) Changed ID nets state on page 9 from '100' (rev4) to '101' (rev5)</li> <li>12) Added UKCA Logo</li> </ul>	MT

	Title: <b>TE0741 - Changes List</b>		
	A4	Number: <b>TE0741 G2C-1-A</b>	Rev. <b>05</b>
	Date: <b>2023-08-02</b>	Copyright: <b>Trenz Electronic GmbH</b>	Page <b>2</b> of <b>20</b>
	Filename: <b>Revision_Changes.SchDoc</b>		

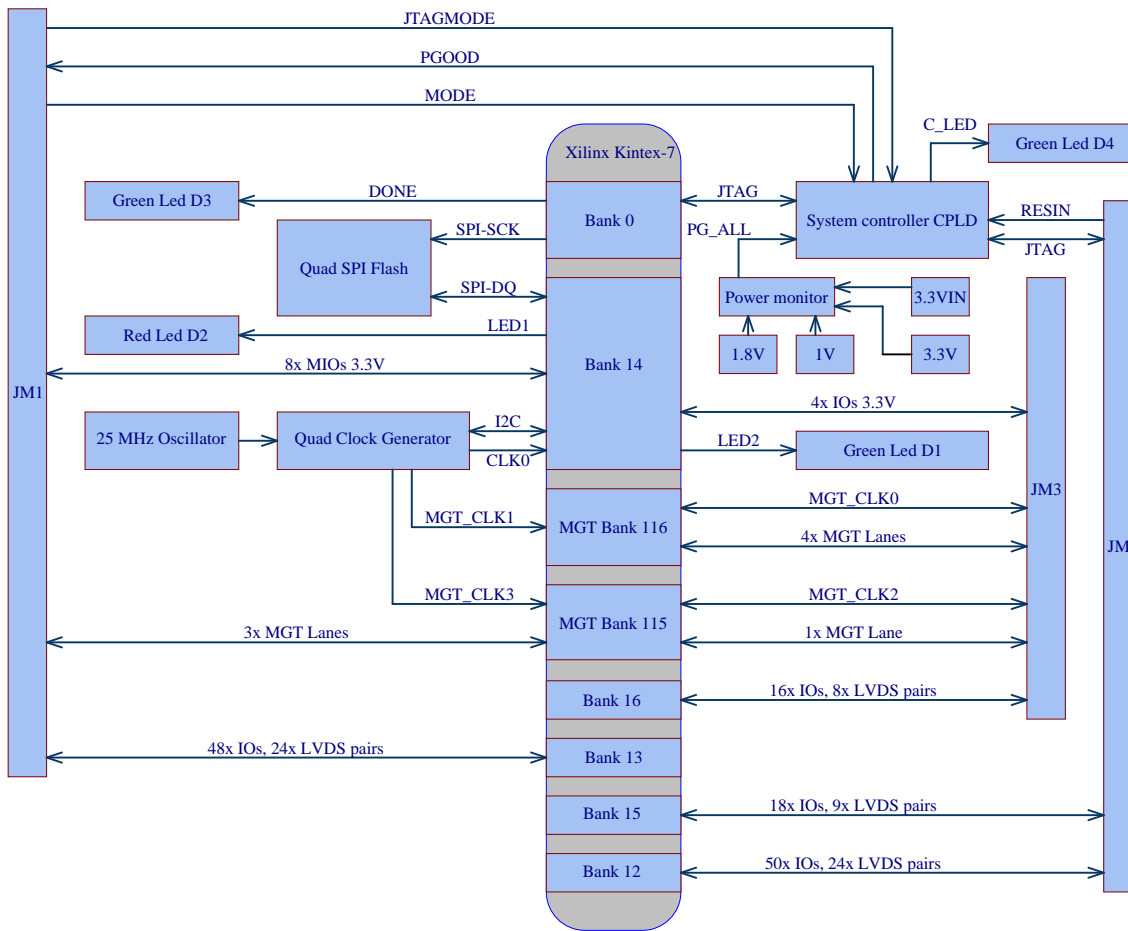

U_Legal Notices Modules	U_B34
U_Revision Changes	U_FPGA_PWR
U_Power_Diagram	U_TE0741
U_B32_B33	U_PWR1



Title: TE0741 - System Overview		
A4	Number: TE0741 G2C-1-A	Rev. 05
Date: 2023-08-02	Copyright: Trenz Electronic GmbH	Page 3 of 20
Filename: Overview.SchDoc		

## Power-on sequencing:

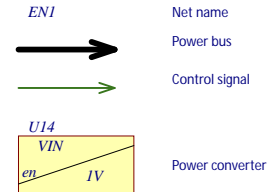
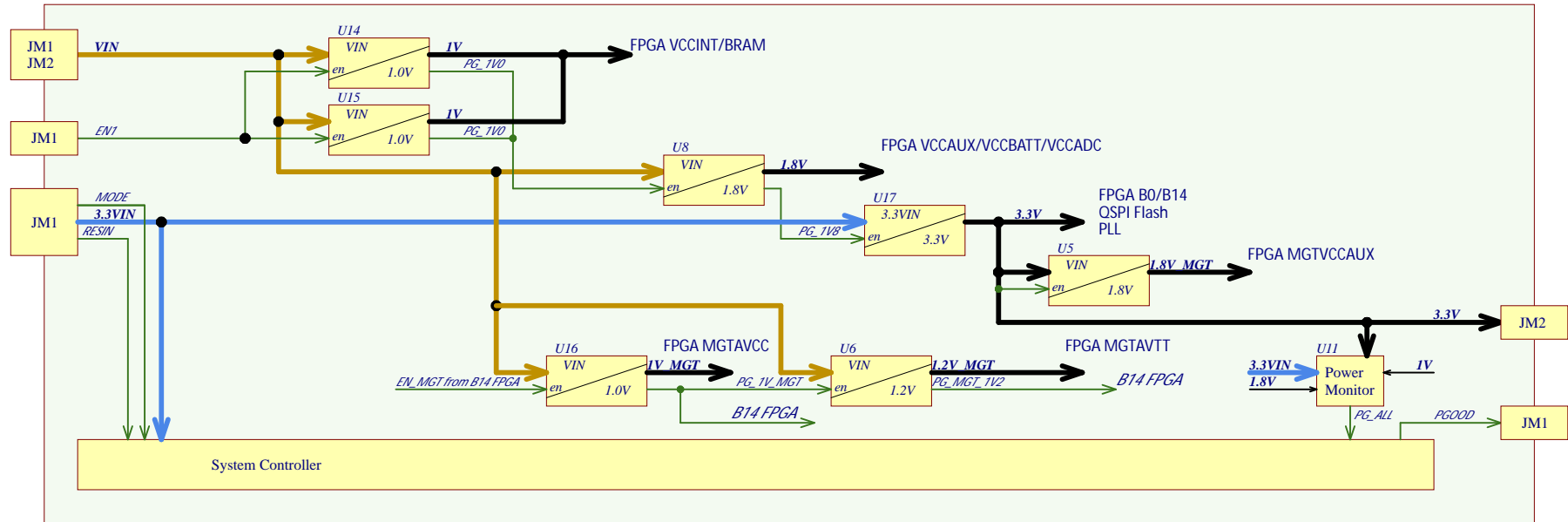

## Supported Voltage Ranges:

Power Rail	Direction	Range	Tolerance	Description	Note
VIN	IN	3.3 - 5.5V	+/-5%	Micromodule Power	-
3.3VIN	IN	3.3V	+/-5%	Micromodule Power	-
VCCIO12	IN	1.2 - 3.3V	+/-3%	HR IO Bank12	-
VCCIO13	IN	1.2 - 3.3V	+/-3%	HR IO Bank13	-
3.3V	IN	3.3V	+/-3%	HR IO Bank14	-
VCCIO15	IN	1.2 - 3.3V	+/-3%	HR IO Bank15	-
VCCIO16	IN	1.2 - 3.3V	+/-3%	HR IO Bank16	-
VBAT_IN	IN	1.1 - 1.8V	+/-3%	Battery Voltage	-
3.3V	OUT	3.3V	+/-3%	Power for Carrier	-

Title: <b>TE0741 - Power Diagram</b>		
A4	Number: <b>TE0741 G2C-1-A</b>	Rev. <b>05</b>
Date: 2023-08-02	Copyright: Trenz Electronic GmbH	Page 4 of 20
Filename: <b>Power_Diagram.SchDoc</b>		

1

2

3

4

Mount.Hole 3.2mm Mount.Hole 3.2mm

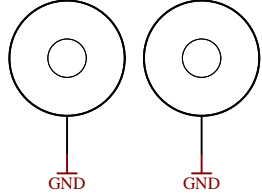

Mount.Hole 3.2mm Mount.Hole 3.2mm

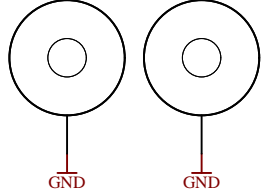

UKCA

UKCA Logo on Top Overlay

UKCA-TOPOVERLAY

Serial

Serial

Serialnumber 6,3 x 6.3mm

Special notes:

FIDU-DOT - mini FIDU-DOT - mini

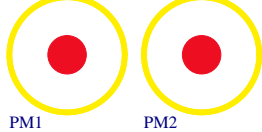

FIDU-DOT - mini FIDU-DOT - mini

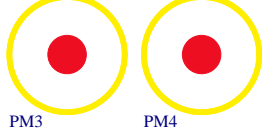

FIDU-DOT - mini FIDU-DOT - mini

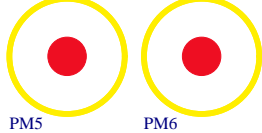

AC coupling on carrier card for nets MGT\_CLK0 is REQUIRED!!!!!!

AC coupling on carrier card for nets MGT\_CLK2 is REQUIRED!!!!!!

Top of Board

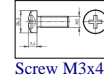

Screw M3x4

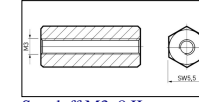

Standoff M3x8 II

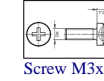

Screw M3x6

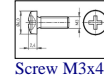

Screw M3x4

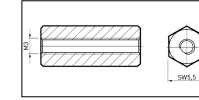

Standoff M3x8 II

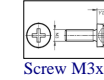

Screw M3x6

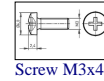

Screw M3x4

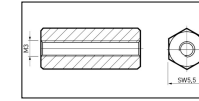

Standoff M3x8 II

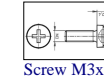

Screw M3x6

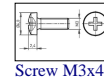

Screw M3x4

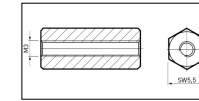

Standoff M3x8 II

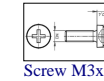

Screw M3x6

Revision PCB Board:

	"0"	"1"	"2"	"3"	"4"	"5"
REV_ID0	0	1	0	1	0	1
REV_ID1	0	0	1	1	0	0
REV_ID2	0	0	0	0	1	1

Search REV\_ID pins on page 9

Assembly variant	G2C-1-A
Created by	VT
Modified by	MT
Modified at	2023-04-16



Title: TE0741		
A4	Number: TE0741 G2C-1-A	Rev. 05
Date: 2023-08-02	Copyright: Trenz Electronic GmbH	Page 5 of 20
Filename: TE0741.SchDoc		

1

2

3

4

A

A

B

B

C

C

D

D

B13 48 IO, 24 LVDS Pairs  
 B14 8 IO, 3.3V  
 MGT 3 Lanes

B16 16 IO, 8 LVDS Pairs  
 MGT 4 + 1 Lanes  
 B14 4 IO, 3.3V

B15 18 IO, 9 LVDS Pairs  
 B12 48 IO, 24 LVDS Pairs  
 B12 2 IO

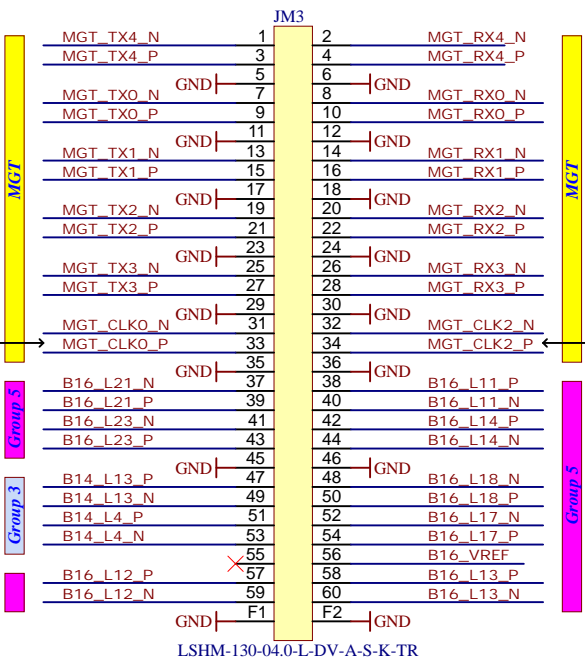
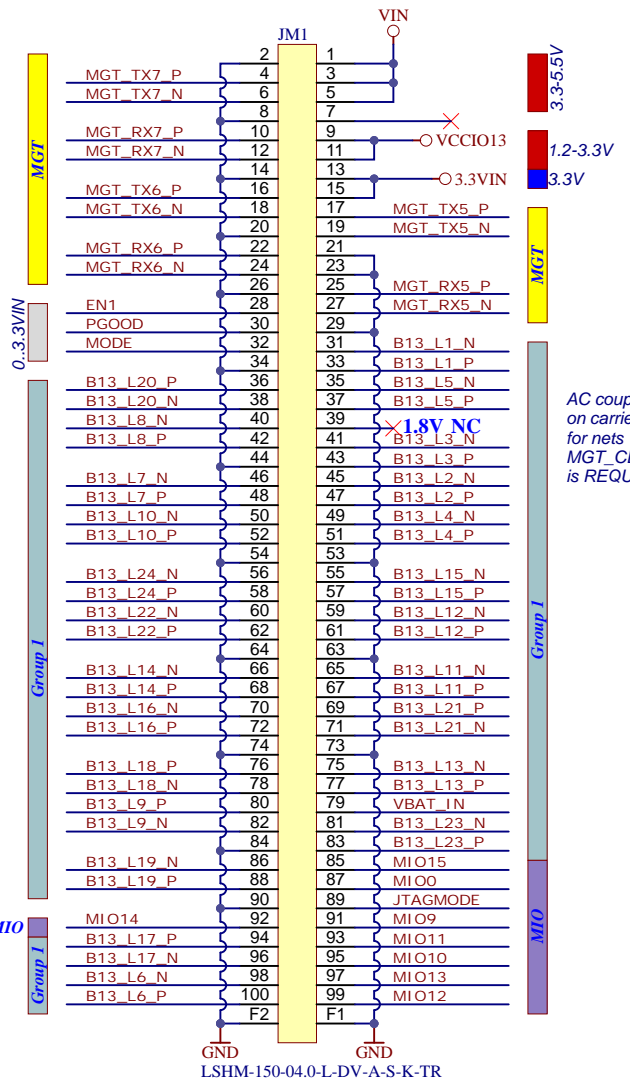

LSHM-130-04.0-L-DV-A-S-K-TR

- VCCIO12 1.2..3.3V
- VCCIO13 1.2..3.3V
- VCCIO14 3.3V
- VCCIO15 1.2..3.3V
- VCCIO16 1.2..3.3V
- MIO 0..3.3VIN
- Group 1 0..VCCIO13
- Group 2 0..VCCIO12
- Group 3 0..VCCIO14
- Group 4 0..VCCIO15
- Group 5 0..VCCIO16
- MGT

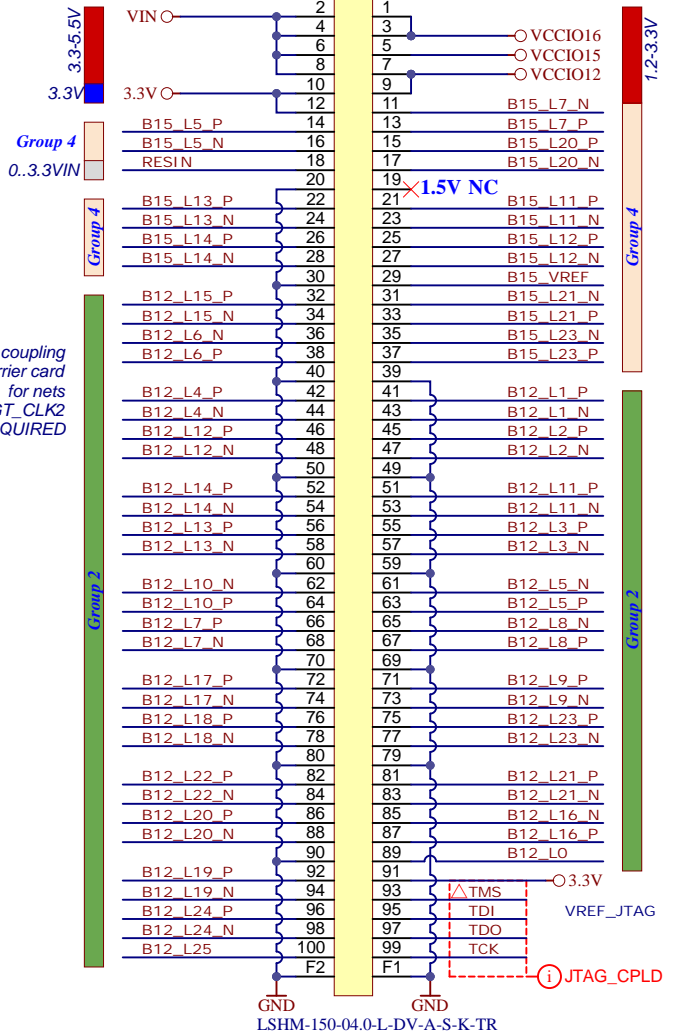

LSHM-150-04.0-L-DV-A-S-K-TR

Some information about Trenz modules compatibility and differences [here](#)

Clock Capable I/O  
 All pins named Bxx\_11\_X  
 Bxx\_12\_X  
 Bxx\_13\_X  
 Bxx\_14\_X  
 Are Clock Capable I/O's





Title: TE0741 - B2B Connectors		
A4	Number: TE0741 G2C-1-A	Rev. 05
Date: 2023-08-02	Copyright: Trenz Electronic GmbH	Page 6 of 20
Filename: B2B-Connectors.SchDoc		

B12\_FIXED ⓘ ▲

B12_L11_P
B12_L11_N
B12_L12_P
B12_L12_N
B12_L13_P
B12_L13_N
B12_L14_P
B12_L14_N
B12_L19_P
B12_L19_N
B12_L6_P
B12_L6_N

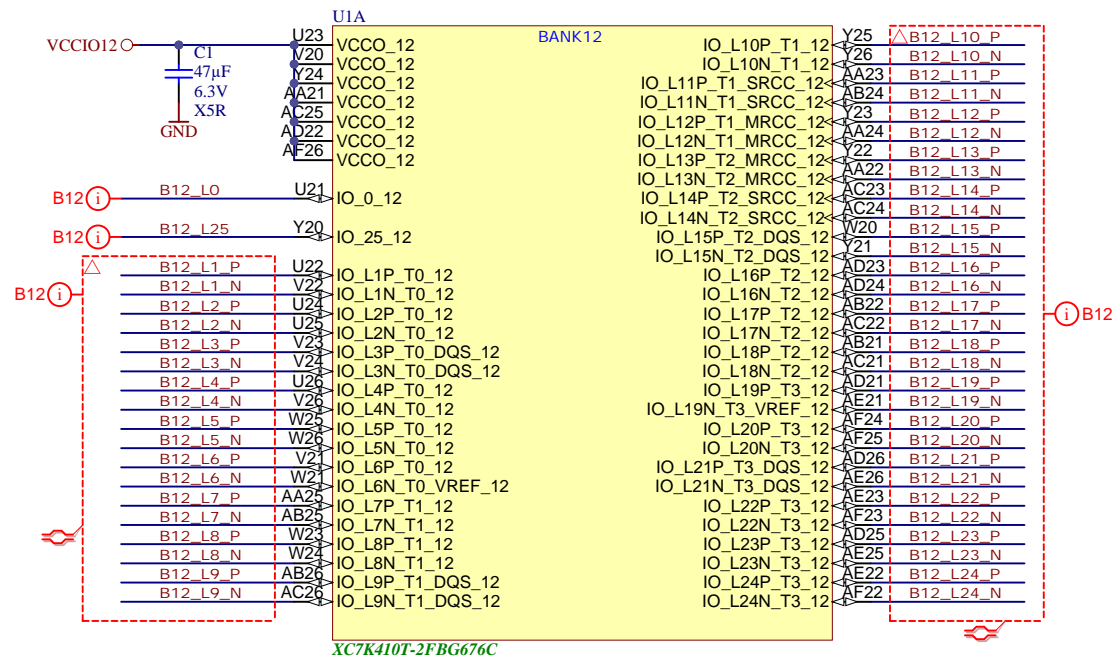
**K70T version does not have this bank!**



	Title: TE0741 - FPGA Bank 12		
	A4	Number: TE0741 G2C-1-A	Rev. 05
	Date: 2023-08-02	Copyright: Trenz Electronic GmbH	Page 7 of 20
	Filename: B12.SchDoc		





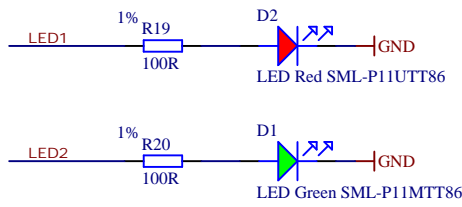
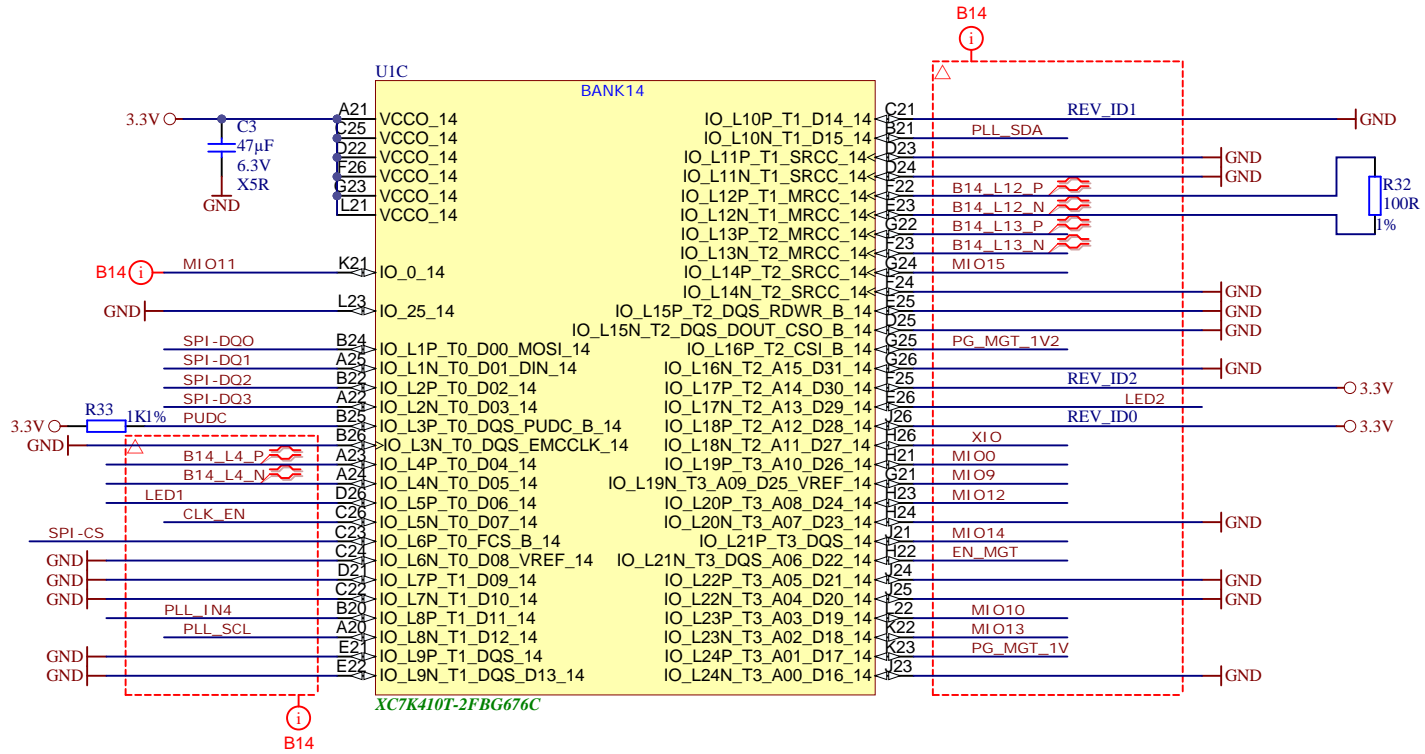



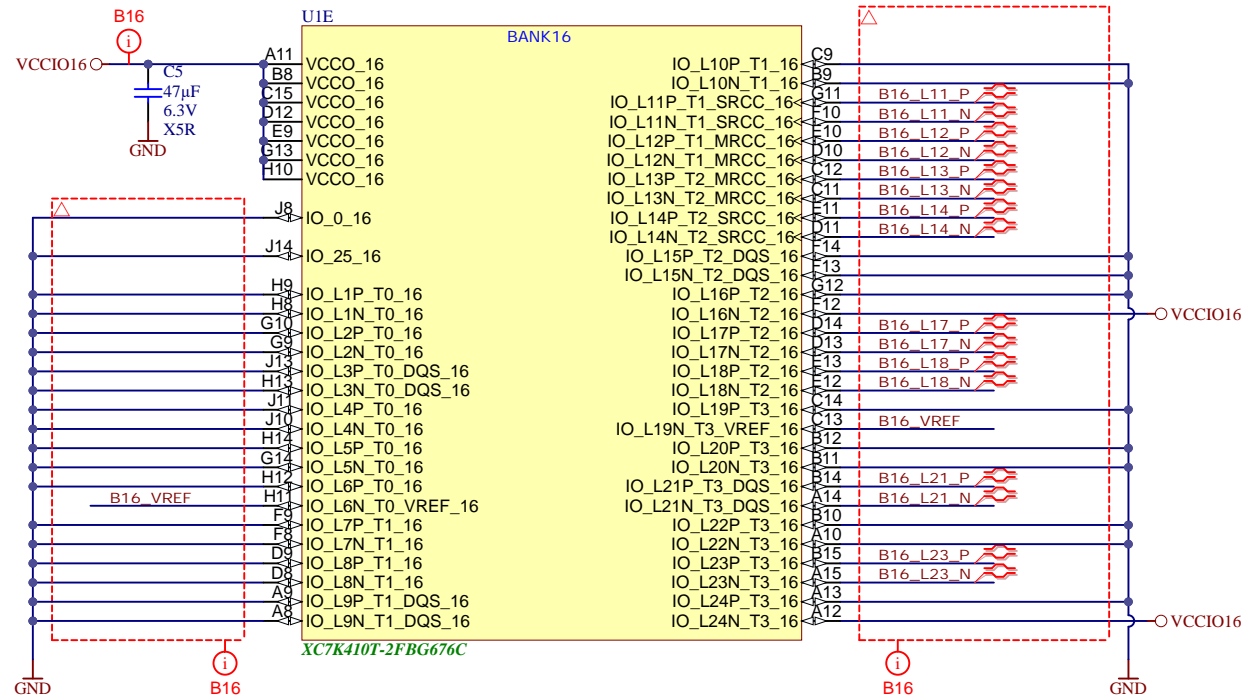

Title: TE0741 - FPGA Bank 14		
A4	Number: TE0741 G2C-1-A	Rev. 05
Date: 2023-08-02	Copyright: Trenz Electronic GmbH	Page 9 of 20
Filename: B14.SchDoc		

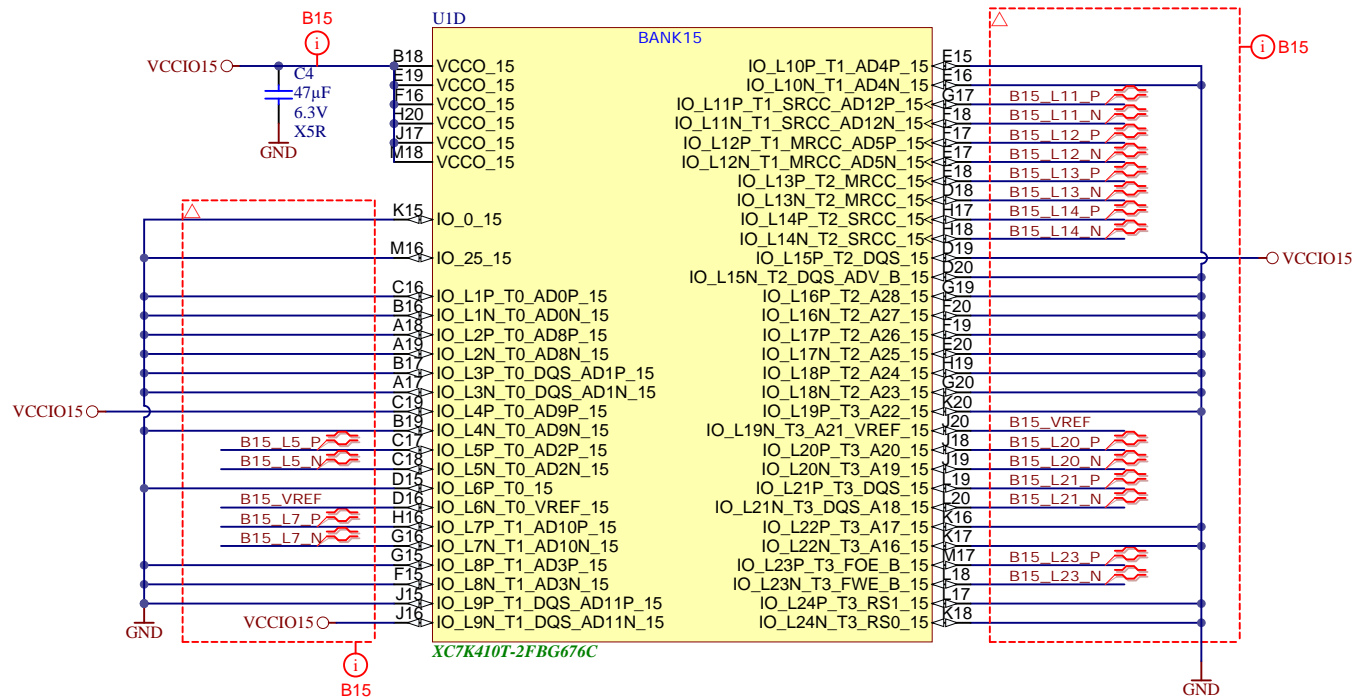

	Title: TE0741 - FPGA Bank 16		
	A4	Number: TE0741 G2C-1-A	Rev. 05
	Date: 2023-08-02	Copyright: Trenz Electronic GmbH	Page 10 of 20
	Filename: B16.SchDoc		

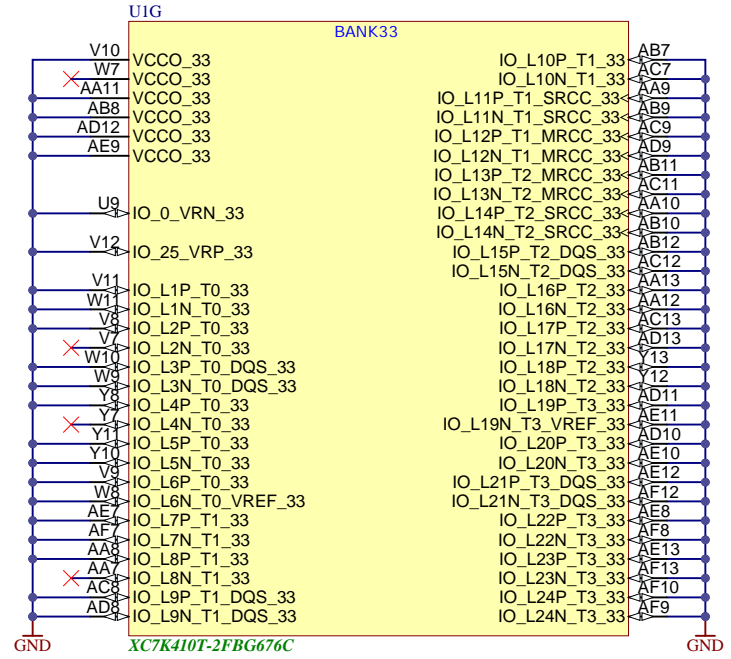
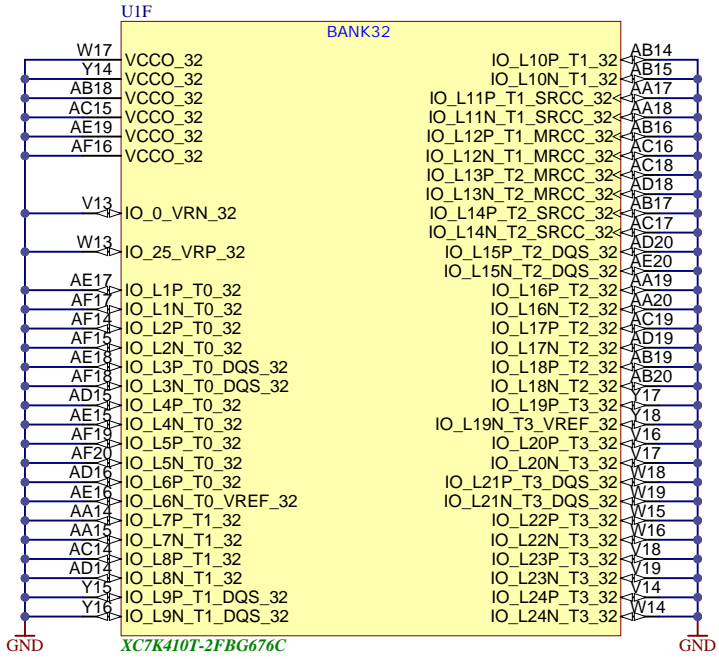

	Title: TE0741 - FPGA Bank 15		
	A4	Number: TE0741 G2C-1-A	Rev. 05
	Date: 2023-08-02	Copyright: Trenz Electronic GmbH	Page 11 of 20
	Filename: B15.SchDoc		

Title: TE0741 - FPGA Banks 32/33		
A4	Number: TE0741 G2C-1-A	Rev. 05
Date: 2023-08-02	Copyright: Trenz Electronic GmbH	Page 12 of 20
Filename: B32_B33.SchDoc		

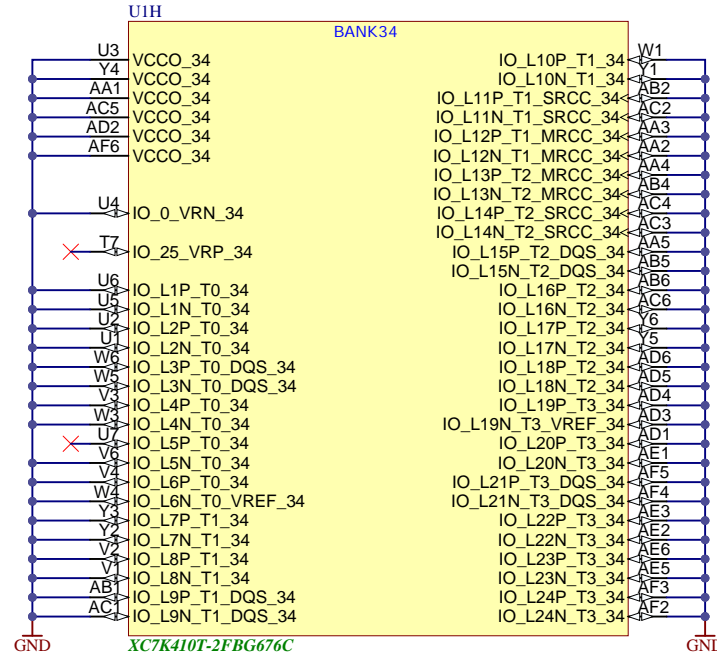

Title: TE0741 - FPGA Bank 34		
A4	Number: TE0741 G2C-1-A	Rev. 05
Date: 2023-08-02	Copyright: Trenz Electronic GmbH	Page 13 of 20
Filename: B34.SchDoc		

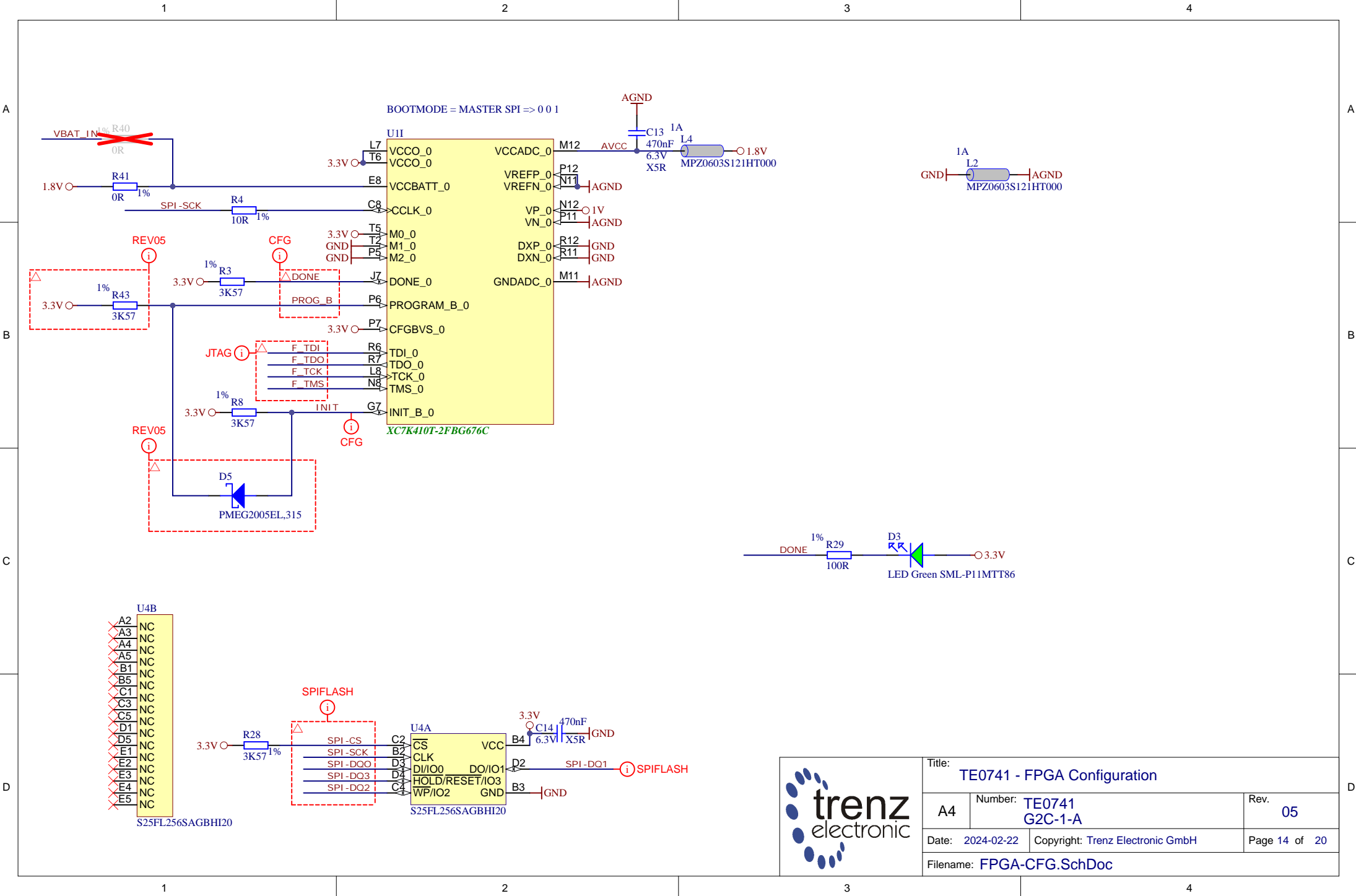

Title: TE0741 - FPGA Configuration		
A4	Number: TE0741 G2C-1-A	Rev. 05
Date: 2024-02-22	Copyright: Trenz Electronic GmbH	Page 14 of 20
Filename: FPGA-CFG.SchDoc		

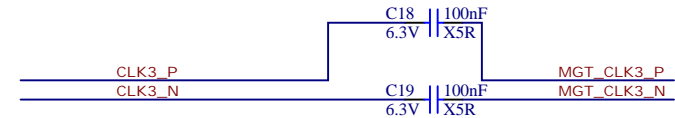
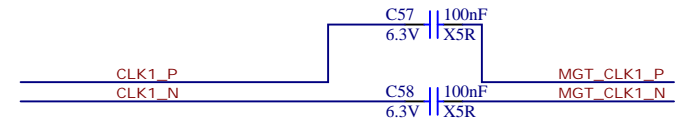
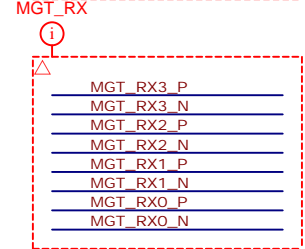
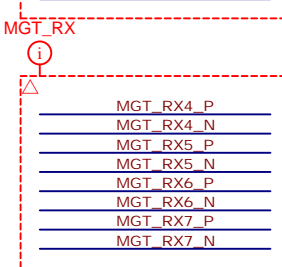
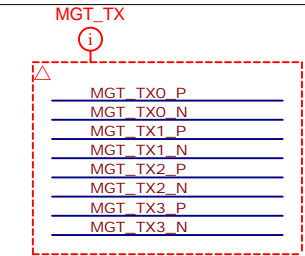
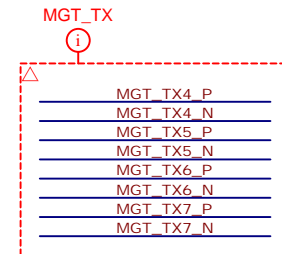
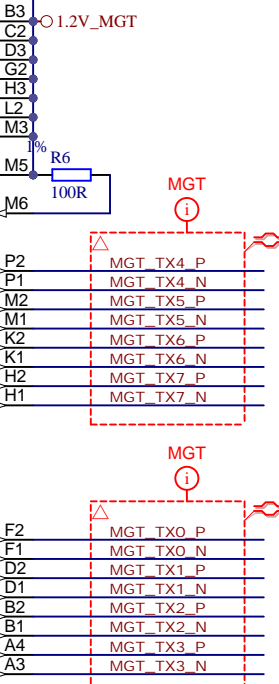
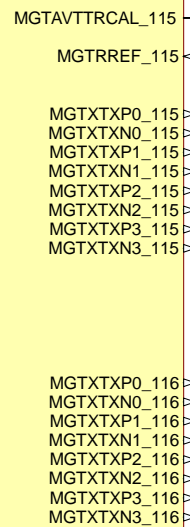
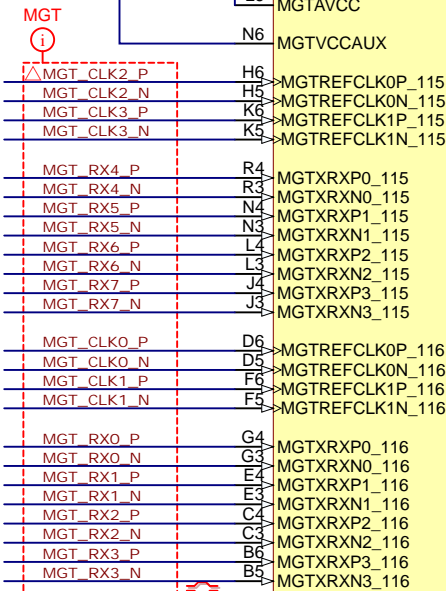
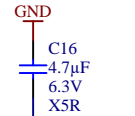
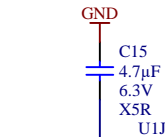
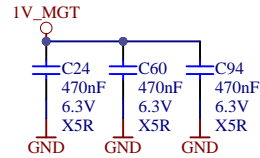
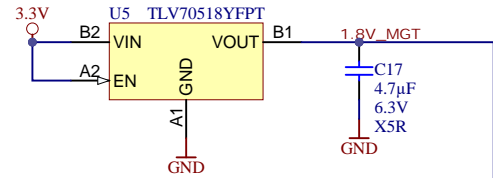

XC7K410T-2FBG676C



Title: TE0741 - FPGA MGT Lanes		
A4	Number: TE0741 G2C-1-A	Rev. 05
Date: 2023-08-02	Copyright: Trenz Electronic GmbH	Page 15 of 20
Filename: FPGA-MGT.SchDoc		

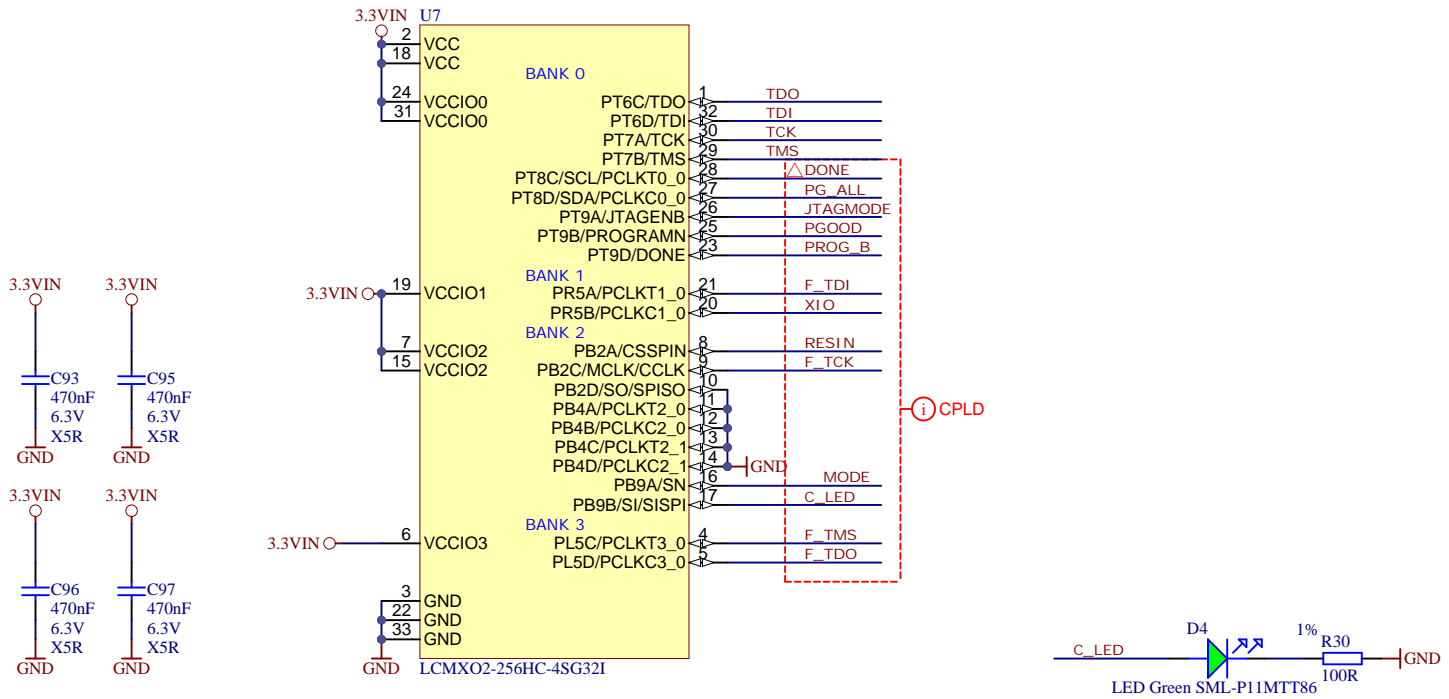

	Title: <b>TE0741 - System Controller</b>		
	A4	Number: <b>TE0741 G2C-1-A</b>	Rev. <b>05</b>
	Date: 2023-08-02	Copyright: Trenz Electronic GmbH	
	Page 16 of 20		
Filename: <b>FPGA-MISC.SchDoc</b>			



1

2

3

4

A

A

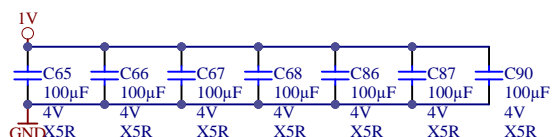
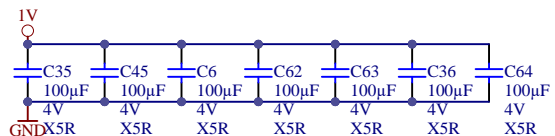
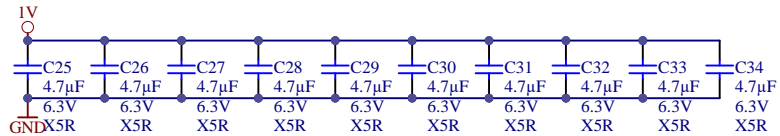

B

B

C

C

D

D

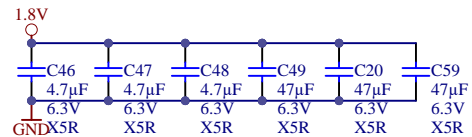

1

2

3

4

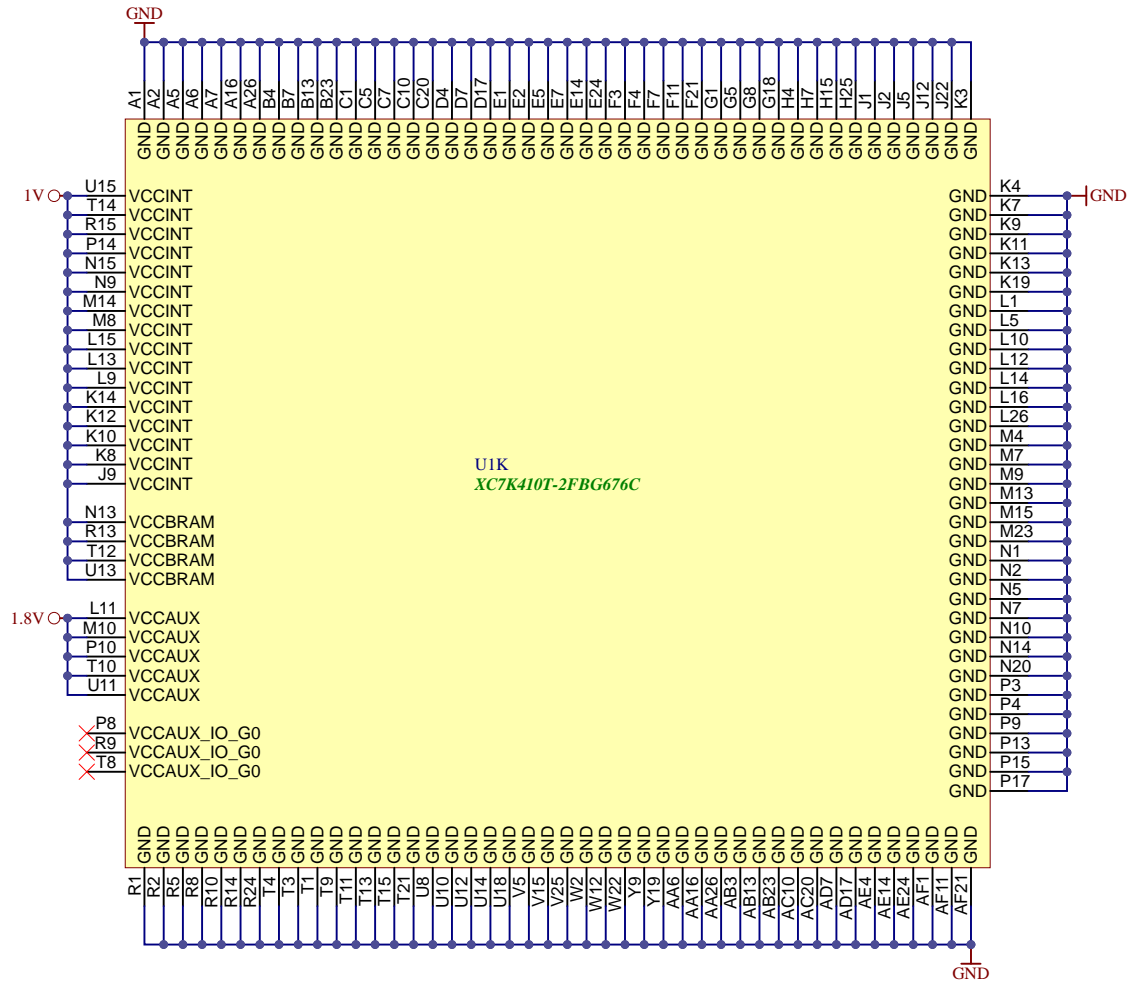

Title: <b>TE0741 - FPGA Power Pinout</b>		
A4	Number: <b>TE0741 G2C-1-A</b>	Rev. <b>05</b>
Date: <b>2023-08-02</b>	Copyright: <b>Trenz Electronic GmbH</b>	Page <b>17</b> of <b>20</b>
Filename: <b>FPGA-PWR.SchDoc</b>		



A

A

B

B

C

C

D

D

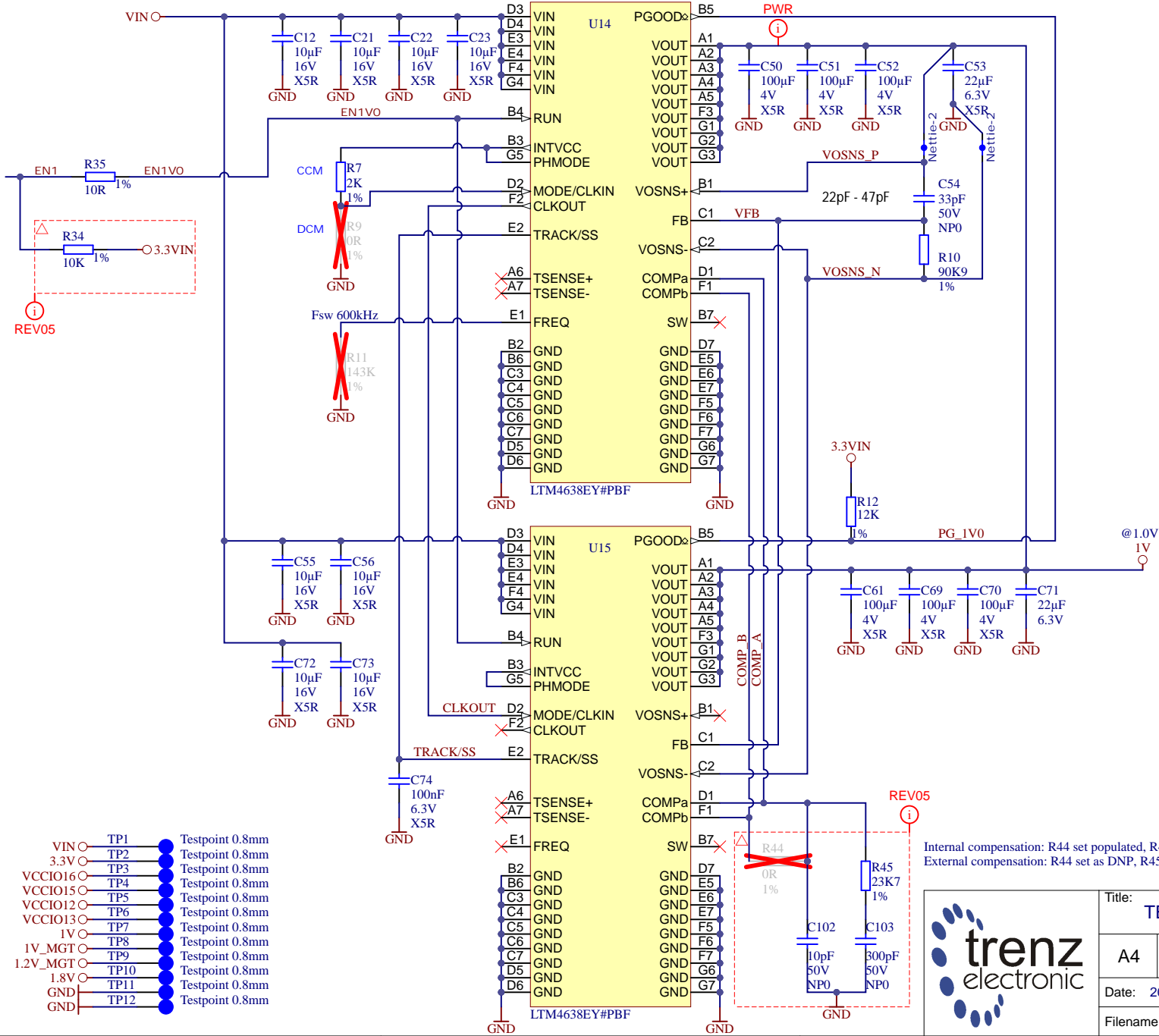

- VIN ○ TP1 ● Testpoint 0.8mm
- 3.3V ○ TP2 ● Testpoint 0.8mm
- VCCIO16 ○ TP3 ● Testpoint 0.8mm
- VCCIO15 ○ TP4 ● Testpoint 0.8mm
- VCCIO12 ○ TP5 ● Testpoint 0.8mm
- VCCIO13 ○ TP6 ● Testpoint 0.8mm
- 1V ○ TP7 ● Testpoint 0.8mm
- 1V\_MGT ○ TP8 ● Testpoint 0.8mm
- 1.2V\_MGT ○ TP9 ● Testpoint 0.8mm
- 1.8V ○ TP10 ● Testpoint 0.8mm
- GND ○ TP11 ● Testpoint 0.8mm
- GND ○ TP12 ● Testpoint 0.8mm

Internal compensation: R44 set populated, R45, C102,C103 set as DNP  
 External compensation: R44 set as DNP, R45, C102,C103 set populated



Title: TE0741 - Power Part 1		
A4	Number: TE0741 G2C-1-A	Rev. 05
Date: 2023-08-02	Copyright: Trenz Electronic GmbH	Page 19 of 20
Filename: PWR1.SchDoc		

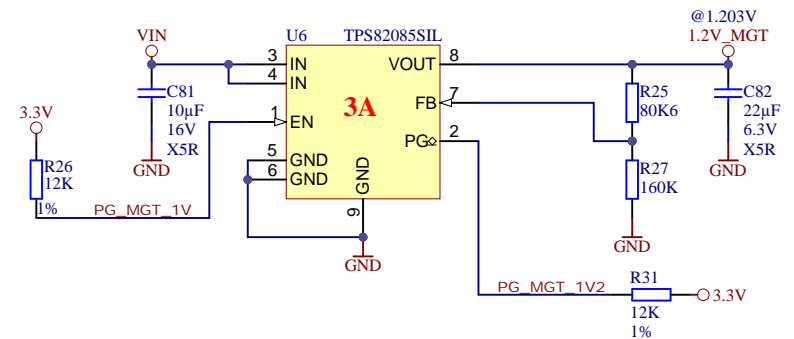
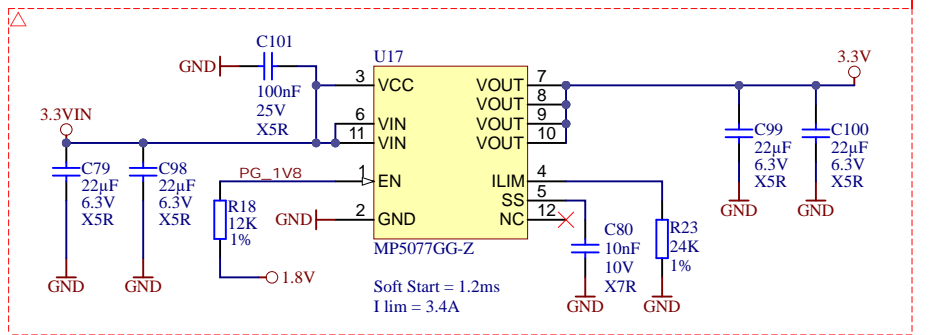
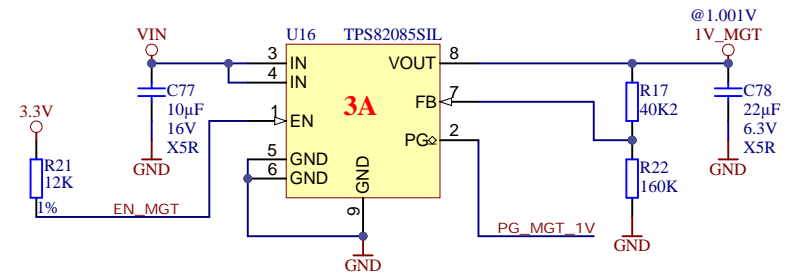
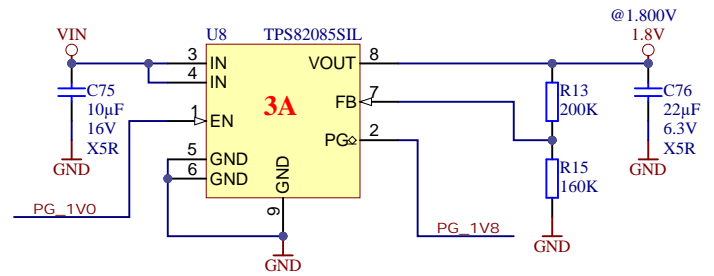
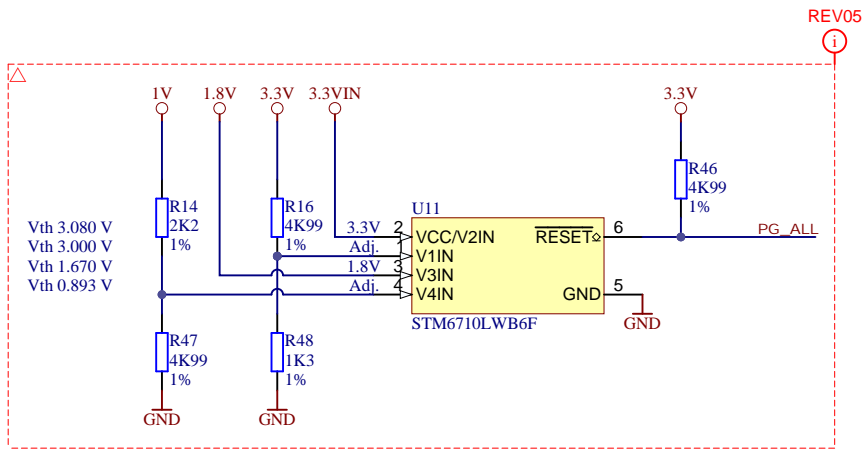

		Title: TE0741 - Power Part 2	
		A4	Number: TE0741 G2C-1-A
Date: 2023-08-02		Copyright: Trenz Electronic GmbH	
Filename: PWR2.SchDoc		Page 20 of 20	