

Variant name: TE0841-02-31C21-A

Top View

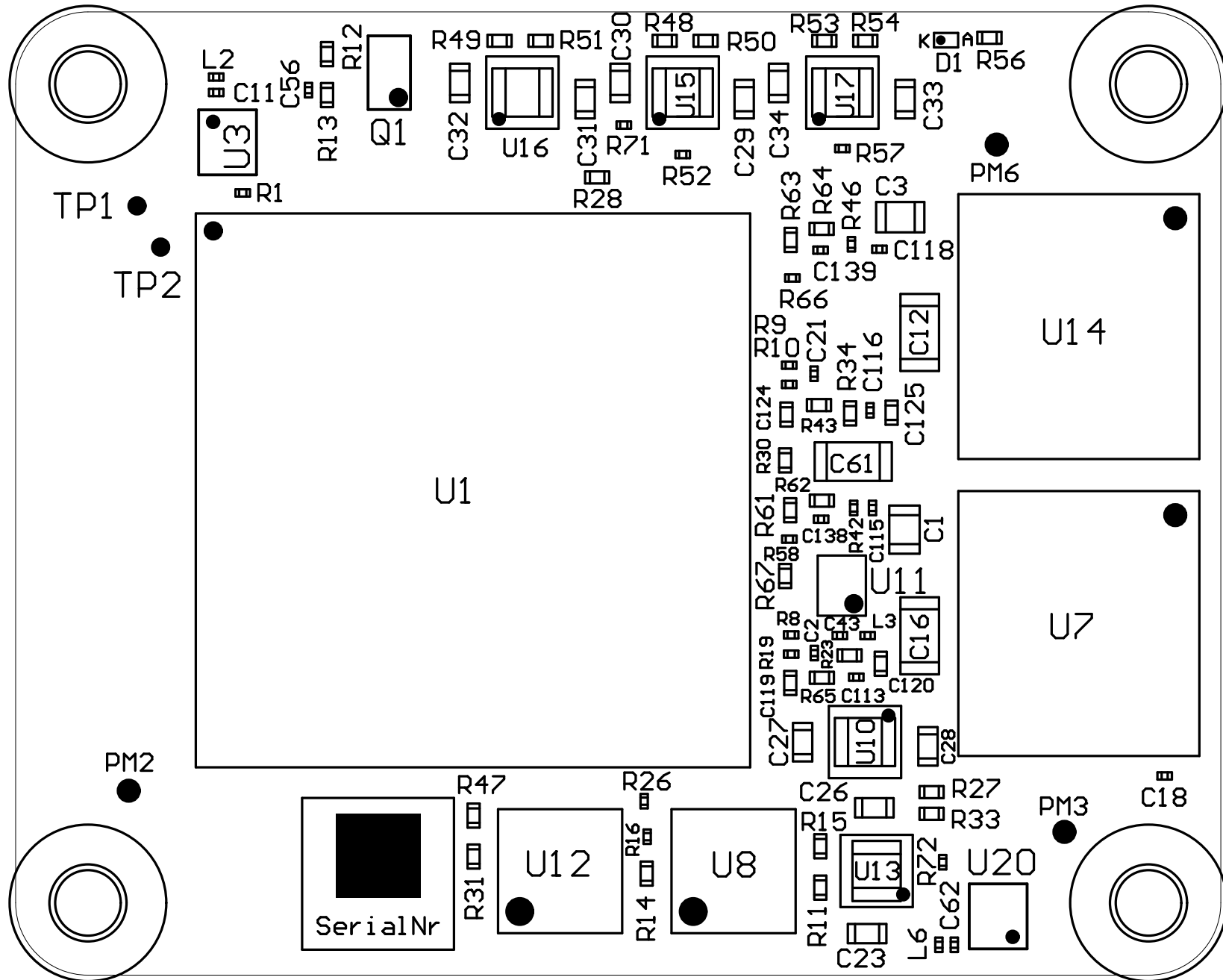

Variant name: TE0841-02-31C21-A

Bottom View

